

Agenda for a meeting of the Waikato District Council to be held in the Council Chambers, District Office, 15 Galileo Street, Ngaaruawaahia on **MONDAY, 18 DECEMBER 2023** commencing at **9.30am**.

Information and recommendations are included in the reports to assist the Committee in the decision-making process and may not constitute Council's decision or policy until considered by the Committee.

The meeting will be opened with a karakia.

1. APOLOGIES AND LEAVE OF ABSENCE

2. CONFIRMATION OF STATUS OF AGENDA

3. DISCLOSURES OF INTEREST

4. MINUTES FOR CONFIRMATION

Minutes for 23 November 2023

5

5. ACTIONS REGISTER

6. COMMITTEE REPORTS

6.1 Policy & Regulatory Committee

Committee Recommendations – 22 November 2023

18

6.2 Waters Governance Board

Board Recommendations – 28 November 2023

59

6.3 Infrastructure Committee

Committee Recommendations – 13 December 2023

61

7. REPORTS

7.1	Zero Harm Update – December 2023	63
7.2	Dog Control Report 2022-2023	69
7.3	Schedule of Meetings 2024	101
7.4	Delegations to the Chief Executive for the Holiday Period 2023-2024	115
7.5	Waikato Scheme Subcommittee	120

8. EXCLUSION OF THE PUBLIC 123

GJ Ion
CHIEF EXECUTIVE

TERMS OF REFERENCE

COUNCIL

Chairperson:	Her Worship the Mayor
Deputy Chairperson:	Deputy Mayor
Membership:	The Mayor and all Councillors
Meeting frequency:	Six weekly – or as required
Quorum:	Half of the members (including vacancies)

Purpose

1. To provide leadership to, and advocacy on behalf of, the people of the Waikato District.
2. To define and represent the total communities' interests, ensuring ongoing community and economic development, the effective stewardship of existing assets, sustainable management of the environment, and the prudent management of the communities' financial resources.

Terms of Reference

The Council's terms of reference include the following powers which cannot be delegated to committees, subcommittees, officers or any other subordinate decision-making body:

1. The power to make a rate.
2. The power to make a bylaw.
3. The power to borrow money, or purchase or dispose of assets, other than in accordance with the Long-Term Plan.
4. The power to adopt a Long-Term Plan, Annual Plan, or Annual Report.
5. The power to appoint a Chief Executive.
6. The power to adopt policies required to be adopted and consulted on under the Local Government Act 2002 in association with the Long-term Plan or developed for the purpose of the local governance statement, including the Council's Infrastructure Strategy.
7. The power to adopt a remuneration and employment policy.
8. The power to approve or amend the Council's Standing Orders.
9. The power to approve or amend the Code of Conduct for elected members, and consider any recommendations made in relation to a complaint lodged under the Code.
10. The power to appoint and discharge:
 - a. members (including chairpersons) of Council committees and subordinate decision-making bodies, subject to the Mayor's powers under section 41A Local Government Act 2002; and
 - b. elected member representatives on external organisations.
11. The power to establish a joint committee with another local authority or other public body and appoint elected members as representatives on such committees or bodies.
12. The power to make the final decision on a recommendation from the Ombudsman where it is proposed that Council not accept the Ombudsman's recommendation.
13. The power to approve or change the District Plan, or any part of that Plan, in accordance with the Resource Management Act 1991.

14. The power to amend or replace the delegations in Council's Delegations Register (except where expressly permitted in the Delegations Register).

To exercise the following powers and responsibilities of Council, which the Council chooses to retain:

1. To approve a proposed policy statement or plan under the Resource Management Act 1991.
2. To approve changes to boundaries of the District under the Resource Management Act 1991 or any other legislation.
3. In respect of District Plan decisions:
 - a. To appoint independent commissioners to a panel for hearings of a Proposed District Plan;
 - b. To approve the recommendation of hearings commissioners on a proposed plan, plan change or variation (including private plan change); and
 - c. To approve a proposed plan or a change to a district plan under Clause 17, Schedule 1 of the Resource Management Act 1991.
4. To adopt governance level strategies, plans and policies which advance Council's vision and strategic goals (e.g. Hamilton to Auckland rail), other than where expressly delegated to a committee.
5. To approve Council's recommendation to the Remuneration Authority for the remuneration of elected members.
6. To approve the Triennial Agreement.
7. To approve resolutions required to be made by a local authority under the Local Electoral Act 2001, including the appointment of an electoral officer and reviewing representation arrangements.
8. To approve any changes to the nature and delegations of any Council committees or subordinate-decision making bodies.
9. To approve the Local Governance Statement.
10. To approve funding requests not allowed for within budgets, in accordance with Significance & Engagement Policy parameters.
11. To approve any additional funding decisions required for the Watercare Services contract.
12. To approve development agreements as recommended by the Development Agreements Subcommittee where infrastructure is not allowed for within the Long Term Plan.
13. To receive six-monthly reports from each Community Board on its activities and projects.

To	Waikato District Council
Report title	Confirmation of Minutes
Date:	7 December 2023
Report Author:	Gaylene Kanawa, Democracy Manager
Authorised by:	Gavin Ion, Chief Executive

1. Purpose of the report

Te Take moo te puurongo

To confirm the minutes for a meeting of the Waikato District Council held on Monday, 20 November 2023.

2. Staff recommendations

Tuutohu-aa-kaimahi

THAT the Waikato District Council confirms the minutes of a meeting held on Monday, 20 November 2023 as a true and correct record.

3. Attachments

Ngaa taapirihanga

Attachment 4A – CCL Minutes – 20 November 2023

Minutes for a meeting of the Waikato District Council held in the Council Chambers, 15 Gallileo Street, Ngaaruawaahia on **MONDAY, 20 NOVEMBER 2023** commencing at **9.35am**.

Present:

Her Worship the Mayor, Mrs JA Church (Chairperson)
Cr C Beavis
Cr C Eyre (Deputy Mayor)
Cr J Gibb
Cr M Keir
Cr P Matatahi-Poutapu (*from 10.05am - Part Item 7.2*)
Cr K Ngataki
Cr E Patterson
Cr M Raumati
Cr V Reeve
Cr L Thomson
Cr P Thomson (*from 10.12am - Part Item 7.2*)
Cr T Turner
Cr D Whyte

Attending:

Mr GJ Ion (Chief Executive)
Mr TG Whittaker (Chief Operating Officer)
Ms M May (General Manager, Service Delivery)
Mr W Gauntlett (General Manager, Community Growth)
Mr L McCarthy (Acting Roothing Manager)
Mr A Singh (Roothing Operations Team Leader)
Ms K Boyt (Roothing Contractor)
Ms J Bishop (Contracts & Partnering Manager)
Ms M Wilson (Contracts & Partnering Advisor)
Ms M Rinaldi (Corporate Planner)
Mrs GJ Kanawa (Democracy Manager)

The Council and staff opened the meeting with a joint karakia.

APOLOGIES AND LEAVE OF ABSENCE

Resolved: (Crs Ngataki/Patterson)

THAT the Waikato District Council accepts the apologies from Cr Matatahi-Poutapu and Councillor P Thomson for late arrival.

CARRIED

WDC2311/01

CONFIRMATION OF STATUS OF AGENDA ITEMS

Agenda Item 2

Resolved: (Crs L Thomson/Eyre)**THAT the agenda for a meeting of the Waikato District Council held on Monday, 20 November 2023 be confirmed:**

- a. with all items therein being considered in open meeting with the exception of those items detailed at agenda items 8, which shall be considered with the public excluded; and
- b. all reports be received.

CARRIED**WDC2311/02****DISCLOSURES OF INTEREST**

Agenda Item 3

Cr Eyre and Cr Patterson noted they would not participate in Item 6.1 – Policy & Regulatory Committee Recommendations - Appointment of Council's Representative on the Future Proof Hearings Subcommittee (P&R2011/05) as they were the recommended appointments.

CONFIRMATION OF MINUTES

Agenda Item 4

The report was received [*WDC2311/02 refers*] and no further discussion held.

Resolved: (Crs Ngataki/Turner)**THAT the Waikato District Council confirms the minutes as a true and correct record for meetings held on:**

- a. Monday, 9 October 2023 (ordinary); and
- b. Tuesday, 24 October 2023 (additional); and
- c. Wednesday, 1 November (extraordinary) 2023.

CARRIED**WDC2311/03****ACTIONS REGISTER**

The report was received [*WDC2311/02 refers*] and no further discussion was held.

COMMITTEE REPORTS

Policy & Regulatory Committee Recommendations – 14 November 2023

Agenda Item 6.1

Adoption of the Freedom Camping Bylaw 2023 (P&R2311/04)

The report was received [WDC2311/02 refers] and no further discussion was held.

Resolved: (Crs Eyre/Keir)

THAT Waikato District Council:

- a. confirms that further consultation is not required under section 76 of the Local Government Act 2002;
- b. confirms, in accordance with Section 11 of the Freedom Camping Act 2011, that a bylaw is necessary in the Waikato District for one or more of the following purposes:
 - i. to protect the area; and
 - ii. to protect the health and safety of people who may visit the area; and
 - iii. to protect access to the area.
- c. confirms, in accordance with Section 11 of the Freedom Camping Act 2011, that the bylaw is the most appropriate and proportionate way of addressing the perceived problem(s) in relation to each area; and
- d. confirms that the bylaw is not inconsistent with the New Zealand Bill of Rights Act 1990; and
- e. notes the changes made to the proposed Freedom Camping Bylaw 2023 (Attachment 1 of the Policy & Regulatory agenda report), as directed during deliberations by the Policy and Regulatory Committee on 16 October 2023; and
- f. that the Freedom Camping Bylaw 2023 (Attachment 2 of the Policy & Regulatory agenda report) be adopted; and
- g. confirms that staff will need to amend reserve management plans to reflect the provisions of the Freedom Camping Bylaw 2023.

CARRIED

WDC2311/04

Appointment of Council's Representative on the Future Proof Hearings Subcommittee (P&R2011/05)

The report was received [WDC2311/02 refers] and no further discussion was held.

Resolved: (Crs Beavis/Gibb)

THAT Waikato District Council appoints:

- a. **Cr Carolyn Eyre (who is the Deputy Mayor and is also one of Waikato District Council's representative on the Future Proof Implementation Committee) be Waikato District Council's representative on the Future Proof Hearings Subcommittee; and**
- b. **Cr Eugene Patterson (who is Council's alternate representative on the Future Proof Implementation Committee) be Cr Eyre's alternate should the latter not be able to discharge her duties.**

CARRIED

WDC2311/05

Recommendation to Adopt – Significance and Engagement Policy (P&R2011/06)

The report was received [WDC2311/02 refers] and no further discussion was held.

Resolved: (Crs Eyre/Ngataki)

THAT Waikato District Council appoints:

- a. **adopts the Significance and Engagement Policy 2023 (Option One – Attachment I of the Policy & Regulatory agenda report), and**
- b. **revokes the Significance and Engagement Policy 2020 (Attachment 3 of the Policy & Regulatory agenda report).**

CARRIED

WDC2311/06

REPORTS

Zero Harm

Agenda Item 7.1

The report was received [*WDC23/1/02 refers*] and the following discussion was held:

- A query was raised as to how Council arrived at a target of 50% reduction in TRIS for the year. The Chief Executive noted this was based on historical trends and currently discussions were underway as to whether this was a good measure.
- It was noted that a further independent review was being undertaken, following a review in 2016 which provided a comprehensive report and queries were made as to why? Staff advised the report needed to be refreshed to ascertain whether some points raised were still relevant and also how we have tracked to date based on the previous report.
- It was further noted that the independent review also covered Hakanoa Camp and the Ngaruawahia Dog Pound, which were not an area of expertise for our team.
- It was noted that a recent media release from the Police advised of a ban from the “Waikato District”, do Council receive notifications of this sort and if so are they advised to elected members? It was noted that this is a police matter and the Waikato District they refer to is quite a bit larger than our District boundaries.

ACTION: Zero Harm Manager would investigate the process for these “bans” with the Waikato District Commander for Police and also ascertain whether the Resilience team were aware of when these bans were made.

- A Councillor raised an issue with the process for dealing with verbal abuse in Council buildings and noted that he was well supported during this occasion within the Ngaruawahia office, however what support is available in the outer areas or when Councillors were visiting residents.
- It was noted that office and library staff were well trained to deal with events of this nature and Council endeavour to provide a secure environment within our offices, including ensuring there are withdrawal areas for everyone to maintain safety.
- It was noted that Community Boards and Committees were bound like any other elected member in the current terms of reference by the current Code of Conduct policy of the previous Council.
- It was further noted that this policy would be reviewed in the New Year and full training provided to elected members (including community committee members) on the requirements under the Council Code of Conduct.
- If Councillors wished to take these matters further, the current policy requires them to discuss with the Mayor for further investigation/discussions with the elected member involved.

- Council could also provide G7 devices for community meetings and recommended that Councillors attend meetings in pairs. It was further noted that at all Community Board meetings the Democracy Advisors were in possession of G7 devices which they could activate in the event of an emergency.
- It was further recommended that if Councillors were going to a residents address that you they did not know to contact Council to see if there are any other issues known at that address.
- There was also Council's support service – Vitae and if they needed this support to contact any of the ELT or Democracy Manager who could provide the details.

ACTION: Zero Harm team to book another Situational Safety Awareness training that was provided to most Councillors during induction, but there were still a few Councillors that had not received this training.

Joint Waikato Iwi, Chairs & Mayors Forum Draft ToR and Position Statement on Water Service Agenda Item 7.2

The report was received [WDC2311/02 refers] and the following discussion was held:

- The Chief Executive provided an overview of the paper and terms of reference, for which Council held a workshop on last week.
- Collaboration opportunities were being worked on now, but was was the timeframe for these? It was noted that we had to wait and see what the Government would do once it was formed – this terms of reference and position statement allowed us to protect partnerships in the interim.
- Asset management system aligned and provided by Watercare now, it was noted that in the future billing systems for water and wastewater charges would have to change and this would cause upheaval for ratepayers.
- There was an expectation that significant improvement in regard to discharges in Raglan needed to be made and whilst progress had been made Council were still a long way from where we wanted to be.
- Currently the legislation indicates we are will enter into a water services agreement on 1 July 2025 with Entity B and Council have planned accordingly, however until the government is formed and we know their direction it is difficult to know anything further.
- It was noted that a system for charging would be similar to what occurs in Auckland, i.e. the water meter on each property records water going in and a portion of that is calculated for storm/wastewater discharge.

Resolved: (Crs Eyre/Turner)

That the Waikato District Council:

- a. **ratifies the draft Terms of Reference for the Joint Waikato Iwi, Chairs and Mayors Forum and Draft Position Statement on Waters Services.**

CARRIED

WDC2311/07

Councillor Matatahi-Poutapu entered the meeting at 10.05am during the above item and was present for the above vote and partial discussion.

Councillor P Thomson entered the meeting at 10.12am during the above item and was present for the vote, but not the discussion.

EXCLUSION OF THE PUBLIC

Agenda Item 8

Resolved: (Crs Patterson/Beavis)

- a. **THAT the public be excluded from the following parts of the proceedings of this meeting:**

The general subject of each matter to be considered while the public is excluded, the reason for passing this resolution in relation to each matter, and the specific grounds under section 48(1) of the Local Government Official Information and Meetings Act 1987 for the passing of this resolution are as follows:

General subject of each matter to be considered	Reason for passing this resolution in relation to each matter	Ground(s) under section 48(1) for the passing of this resolution
Item PEX 2 – Minutes for confirmation	Good reason to withhold exists under Section 6 or Section 7 Local Government Official Information and Meetings Act 1987	Section 48(1)(a)
Item PEX 3.1 – Chief Executive Performance Review Committee – Minutes for 17 September 2023 (For Information Only)		
Item PEX 3.2 – Infrastructure Committee – 8 November 2023		
Item PEX 4.1 – Roding Services Contract Review		
Item PEX 4.2 – Strategic Land Acquisition - Pookeno		

This resolution is made in reliance on section 48(1)(a) of the Local Government Official Information and Meetings Act 1987 and the particular interest or interests protected by Section 6 or Section 7 of that Act which would be prejudiced by the holding of the whole or relevant part of the proceedings of the meeting in public, as follows:

Item No.	Section	Interest
Item PEX 2 – Minutes for confirmation	Refer previous minutes for reasons for exclusion.	
Item PEX 3.1 – Chief Executive Performance Review Committee – Minutes for 17 September 2023 (For Information Only)	7(2)(a)	To protect a person’s privacy.
Item PEX 3.2 – Infrastructure Committee – 8 November 2023	Refer to Infrastructure Committee agenda for reasons for exclusion.	
Item PEX 4.1 – Roading Services Contract Review	7(2)(i)	To enable negotiations to carry on without prejudice or disadvantage.
Item PEX 4.2 – Strategic Land Acquisition - Pookeno	7(2)(i)	To enable negotiations to carry on without prejudice or disadvantage.

CARRIED

WDC2311/07

Resolutions WDC2311/08 -WDC2311/13 are contained in the public excluded section of these minutes.

Having concluded the public excluded meeting the following items were released into open meeting:

REPORTS (CONTINUED)

Infrastructure Committee Recommendations - 8 November 2023
PEX Agenda Item 3.2

Strategic Land Acquisition – Raglan (INF2311/09)

It was resolved [WDC2311/10] during the public excluded section of the meeting that the following resolution be released into open meeting but the report remain confidential and unavailable to the public:

Resolved: (Crs Patterson/Whyte)

“THAT the Waikato District Council:

- a. approves the purchase of the property at 398 Wainui Road, Raglan.
- b. delegates to the Chief Executive to conclude a negotiation at a price he deems reasonable guided by the registered valuation and on terms suitable to protect Council’s interest.
- c. notes that the property purchase will be funded from the Strategic Property District Wide budget using cost centre 104662-1200-0000-00-50007 and held as a Strategic Property until such time it is required for road.
- d. resolves to release the resolutions into the open meeting at the conclusion of the settlement of a successful land purchase, but the report remains confidential and unavailable to the public.

CARRIED”

Roading Services Contract Review

PEX Agenda Item 4.1

It was resolved [WDC231111] during the public excluded section of the meeting that the following resolution be released into open meeting but the report remain confidential and unavailable to the public:

“Resolved: (Crs Keir/Patterson)

THAT the Waikato District Council:

- a. approves use of NZS3917 contract model to procure the Road Maintenance and Renewal Services for a start date of 1 July 2025; and
- b. approves the release of this resolutions into the open meeting, but the report remains confidential and unavailable to the public.

CARRIED”

To	Waikato District Council
Report title	Actions Register – December 2023
Date:	5 December 2023
Report Author:	Kaye Whitfield, Executive Assistant to Chief Executive
Authorised By:	Gavin Ion, Chief Executive

1. Purpose of the report

Te Take moo te puurongo

To update the Council on actions arising from the previous Council meeting.

2. Staff recommendations

Tuutohu-aa-kaimahi

That the Waikato District Council receives the Actions Register for December 2023.

3. Attachments

Ngaa taapirihanga

Attachment 1 – Actions Register

17
Waikato District Council - Actions Register
December 2023

Meeting Date	Item and Action	Person / Team Responsible	Status Update
7/11/2023	Zero Harm Manager would investigate the process for the "bans" from the Waikato District with the Waikato District Commander for Police and also ascertain whether the Resilience team were aware of when these bans were made.	Lynn Shirley	<ul style="list-style-type: none"> Followed up with the Risk and Resilience Team to determine if we have any arrangements regarding receiving intel of this nature from the Police. We currently do not. Chief Executive to reach out to District Commander regarding if this is possible.
7/11/2023	Zero Harm team to book another Situational Safety Awareness training that was provided to most Councillors during induction, but there were still a few Councillors that had not received this training.	Lynn Shirley	<ul style="list-style-type: none"> Currently working with training provider to arrange more training for the first quarter of 2024.

To	Waikato District Council
Report title	Policy & Regulatory Committee Recommendations – 22 November 2023
Date:	Tuesday, 5 December 2023
Report Author:	Elizabeth Saunders, Senior Democracy Advisor
Authorised by:	Gaylene Kanawa, Democracy Manager

1. Executive summary

Whakaraapopototanga matua

The purpose of this report is to seek the Council's approval of the recommendation from the Policy & Regulatory Committee meeting held on Wednesday, 22 November 2023.

The Policy & Regulatory Committee agenda and attachments from the meeting on Wednesday, 22 November 2023 can be found on the Council website via the following link:

https://www.waikatodistrict.govt.nz/docs/default-source/meetings/agenda-2023/231122-p-r-water-supply-by-law-hearing-deliberations-agenda.pdf?sfvrsn=9b3c6ac8_1

2. Staff recommendations

Tuutohu-aa-kaimahi

Proposed Water Supply Bylaw 2023 (P&RHE2311/04)

THAT the Policy and Regulatory Committee:

- a. considers all submissions and the contents of this report in their deliberations on the proposed Water Supply Bylaw 2023;*
 - b. determines that Council has followed the requirements for consultation under the Local Government Act 2002 Section 83;*
 - c. confirms that further consultation is not required under section 76 of the Local Government Act 2002;*
 - d. reconfirms, in accordance with Section 155 of the Local Government Act 2002, a bylaw is the most appropriate way of addressing the perceived problem(s) in relation to the water supply network;*
 - e. confirms, in accordance with Section 155 of the Local Government Act 2002, that the bylaw is not inconsistent with the New Zealand Bill of Rights Act 1990 and that the bylaw is the most appropriate form of bylaw;*
-

THAT the Waikato District Council:

- f. revokes the Water Supply Bylaw 2014 (amended in 2021) (Attachment 2); and**
- g. adopts the Water Supply Bylaw 2023 (Attachment 1), subject to changes directed by the Committee.**

3. Attachments

Ngaa taapirihanga

Attachment 1 – Proposed Water Supply Bylaw 2023

Link to Policy & Regulatory Open Agenda:

https://www.waikatodistrict.govt.nz/docs/default-source/meetings/agenda-2023/231122-p-r-water-supply-bylaw-hearing-deliberations-agenda.pdf?sfvrsn=9b3c6ac8_1

Waikato District Council Water Supply Bylaw 2023

The Waikato District Council, in exercise of its powers and authorities conferred on it under the Local Government Act 2002 and its respective amendments, and all other relevant powers, makes the following bylaw.

1. Introduction

- 1.1. Waikato District Council (the Council) has the ability to make bylaws for the purposes of protecting, promoting and maintaining public health and safety.
- 1.2. Council has a duty under Section 17 of the Waikato River Settlement Act 2010, to have regard to Te Ture Whaimana o Te Awa o Waikato (the vision and strategy for the Waikato River). The vision is “for a future where a healthy Waikato River sustains abundant life and prosperous communities who, in turn, are all responsible for restoring and protecting the health and well-being of the Waikato River, and all it embraces, for generations to come”. In this regard, the Council recognizes the special, cultural, social, environmental and economic relationship of Waikato-Tainui with the Waikato River and the need to protect and restore the Waikato River.

Advisory Note: the above introduction does not form part of this Bylaw and is intended to be read as an introductory note.

2. Short Title, Commencement and Application

- 2.1. The Bylaw shall be known as the “Waikato District Council Water Supply Bylaw 2023”.
- 2.2. The Bylaw shall apply to the Waikato District.
- 2.3. The Bylaw shall come into force on 22 December 2023.

3. Scope

This Bylaw shall apply to the Waikato District (within the boundaries of the Waikato District pursuant to the Local Government Act 2002) and any land, building, work, or property under the control of the Council.

4. Purpose

- 4.1. The purposes of this Bylaw are:

(a) Promoting the efficient use of water and protecting against waste or

misuse of water from the water supply network.

- (b) Protecting the water supply and water supply network from pollution and contamination.
- (c) Managing and protecting from damage, misuse, or loss of land, structures and infrastructure associated with the water supply network.
- (d) Preventing the unauthorised use of land, structures or infrastructure associated with the water supply network.

5. Compliance with Other Acts and Codes

This Bylaw is made under the authority of the Local Government Act 2002 for the supply of water to its customers in its capacity as a Water Supply Authority. The supply and sale of water by the Council is subject to:

- (a) Statutory Acts and Regulations, including.
 - i. Building Act 2004.
 - ii. Fire and Emergency Act 2017.
 - iii. Local Government (Rating) Act 2002.
 - iv. Local Government Act 2002.
 - v. Resource Management Act 1991.
 - vi. Water Services Regulator Act 2020.
 - vii. Water Services Act 2021.
 - viii. Water Services Entities Act 2022.
 - ix. Te Ture Whaimana – the Vision and Strategy for the Waikato and Waipā Rivers.
- (b) This bylaw is subject to the relevant Codes and Standards, including:
 - i. Water Services (Drinking Water Standards for New Zealand) Regulations 2022.
 - ii. Drinking Water Quality Assurance Rules 2022.
 - iii. OIML R49: Water meters intended for the metering of cold potable

- water and hot water. Part 1: Metrological and technical requirements; Part 2: Test methods and Part 3: Test report format.
- iv. SNZ PAS 4509: 2008 New Zealand Fire Service Fire Fighting Water Supplies Code of Practice.
 - v. NZS 4503:2005 Hand operated fire-fighting equipment.
 - vi. NZS 4517:2010 Fire sprinkler systems for houses.
 - vii. NZS 4515:2009 Fire sprinkler systems for life safety in sleeping occupancies (up to 2000 square meters).
 - viii. NZS 4541:2020 Automatic fire sprinkler systems.
 - ix. Backflow Prevention for Drinking Water Suppliers Code of Practice 2006, Water New Zealand.
 - x. Water Meter Code of Practice 2003, Water New Zealand.
 - xi. Resource Management (National Environmental Standards for Sources of Human Drinking Water) Regulations 2007.
 - xii. Waikato Regional Infrastructure Technical Specification.
 - xiii. National Engineering Design Standards.

6. Interpretation

- 6.1. When interpreting this Bylaw, use the definitions set out in clause 7 unless the context requires otherwise. Where reference is made in this Bylaw to any repealed enactment, such reference should be taken as a reference to its replacement.
- 6.2. For the purpose of this Bylaw, the word 'shall' refers to requirements that are mandatory for compliance with this Bylaw, while the word 'should' refers to practices that are advised or recommended.

7. Definitions

- 7.1. For the purposes of this Bylaw, unless inconsistent with the context, the following definitions apply:

Advisory Note

A note which further explains a Bylaw clause but does not form part of the Bylaw.

Air Gap	A vertical air gap between the outlet of the water supply fitting which fills a storage tank, and the highest overflow water level of that storage tank.
Approved	Approved in writing by the Council, either by an authorised officer of the Council or by resolution of the Council.
Authorised Agent	Any person authorised or appointed by the Council to do anything in respect of the water supply network.
Authorised Officer	Any officer of the Council or other person authorised under the Local Government Act 2002 and authorised by the Council to administer and enforce its Bylaws.
Auxiliary Supply	A water supply, other than the Council's system, on or available to a Customer system. These auxiliary supplies may include water from another provider's public potable water supply or any natural source(s) such as a well, spring, river, stream, or "used waters" or "industrial fluids."
Backflow	The unplanned reversal of flow of water or mixtures of water and contaminants into the water supply network.
Backflow Device	Backflow device or air gap that is designed to prevent the return of flow into the Council's water supply network. These devices can include non-return valves, reduce pressure zone devices, and double check valves.
Boundary	Legal boundary of the site, or in the case of more than one premise on a site, it is defined by the notional boundary of a complying unit site area.
Catchment	An area of land which drains to a waterbody from where a public water supply is drawn.

Commercial Use	The use of land and buildings for the display, offering, provision, sale or hire of goods, equipment or services and includes shops, markets, showrooms, restaurants, cafes, takeaway food bars, professional, commercial and administration offices, service stations, motor vehicle sales, visitor accommodation, the sale of liquor and parking areas associated with any of the above.
	<i>Advisory Note: Commercial components of retirement villages will be metered and classified as commercial activity.</i>
Connection	The valve, meter and associated fittings installed and maintained by the Council on the service pipe or at the point of supply.
Council	The Waikato District Council and includes an officer authorised to exercise the authority of the Council.
Customer	A person who has obtained the right to use or direct the manner of use of water supplied by the Council to any premises.
Domestic Water Use	Water taken and used for the purpose of providing for individual household use and for human drinking and sanitation needs and excludes any commercial or industrial use.
Development contribution	As defined in the Local Government Act 2002 and the relevant Waikato District Council Development Contributions Policy.
District	The Waikato District.
Extraordinary Supply	A category of on demand supply used for extraordinary use including all purposes for which water is supplied, other than an ordinary supply, and which may be subject to specific conditions and limitations.
Extraordinary Use	Any use of water which is outside of ordinary use and which may be subject to specific conditions and limitations including but not limited to water

alerts and emergency provisions. This applies to the following water users:

- (a) Residential properties with spas, swimming pools or collapsible pools in excess of 6 cubic metres capacity;
- (b) Residential properties with fixed garden irrigation systems;
- (c) Commercial or business premises (including home-based commercial activities);
- (d) Industrial premises.
- (e) Any properties at which agricultural, horticultural or viticultural land use is occurring;
- (f) Lifestyle blocks (rural supplies);
- (g) Fire protection systems other than sprinkler systems installed to comply with NZS 4517;
- (h) Outside of Waikato District customers (supply to, or within another local authority);
- (i) Temporary suppliers;
- (j) Any other property found by Council to be using water above 15m³/day (a consent from the Waikato Regional Council is required);
- (k) Water carriers;
- (l) Any other auxiliary supply.

Fees and Charges

The fees and charges for water supply set by the Council.

Fire Main Supply

A category of supply from pipework installed for the purpose of fire protection only.

Individual Customer Agreement	An agreement between the Council and a water user that outlines both parties' rights and responsibilities for the supply and use of water.
Isolation Valve	The valve at the Customer end of the service pipe used to control and/or isolate the supply. This is also known as the service valve or toby.
Level of Service	The measurable performance standards on the basis of which the Council undertakes to supply water to its Customers.
NZS	New Zealand Standard.
On Demand Supply	A supply which is available on demand direct from the point of supply, subject to the agreed level of service.
On Demand Water Supply Area	An area serviced by a Council owned reticulated water supply network as defined in Schedule 3: Water Supply Area Maps, that is intended to supply water to Customers via on demand supplies with firefighting capability.
Ordinary Supply	A category of on demand supply used solely for domestic purposes, excluding any identified extraordinary water use.
Owner	The person or entity having legal ownership of the premises receiving a supply of water from the Council.
Occupier	The person or legal entity having a legal right to occupy, use all or part of the premises receiving a supply of water from the Council that includes a tenant, lessee, licensee, manager, foreperson or any other person acting in the general management of any premises.
Permit	A permit or written authority issued by an authorised officer.
Person	An individual, corporation sole, or a body of persons whether corporate or otherwise.

Point of Supply The point on the water pipe leading from the water main to the premises, which marks the boundary of responsibility between the Customer and the Council.

Potable Water Water that does not contain or exhibit any determinants to any extent that exceeds the maximum acceptable values (other than aesthetic guideline values) specified in the New Zealand Drinking Water Standards applicable at the time.

Premises The physical location to which a water supply is provided and includes:

- (a) a property or allotment which is held in a separate certificate of title or for which a separate certificate of title may be issued, and in respect of which a building consent has been or may be issued;
- (b) a building or part of a building which has been defined as an individual unit by a cross-lease, unit title or company lease;
- (c) an individual unit in a building where units are separately leased; or land held in public ownership (e.g. reserve) for a particular purpose.

Advisory Note: Allotment means the same as defined in the Land Transfer Act 1952.

Property A property or allotment which is held under separate certificate of title and a separate rating unit and showing on the Rating Information Database.

Prescribed charges Charges applicable at the time of connection may include:

- (a) Payment to the Council for the cost of the physical works required to provide the connection.
- (b) A development contribution determined in accordance with the Local Government Act

2002.

- (c) A financial contribution determined in accordance with the Resource Management Act 1991.
- (d) Bacteriological and chemical testing as per the Drinking Water Standards for New Zealand to ensure connection is safe.
- (e) Individual agreement charges.

Public Notice

A notice published in:

- (a) One or more daily newspapers circulated in the region or district of the Council;
- (b) One or more other newspapers that have at least an equivalent circulation in that region or district to the daily newspapers circulating in that region or district; or
- (c) Includes any other public notice that the Council thinks desirable in the circumstances.

Restricted Flow Supply

A type of water supply connection where a small flow is supplied through a flow control device, and storage is provided by the Customer to cater for demand fluctuations.

Restrictor

A flow control device installed within the connection to control the flow rate of water to a Customer's premises.

Restricted Water Supply Area

An area serviced by a Council owned reticulated water supply network outside on demand areas and defined in Schedule 3: Water Supply Area Maps Water is supplied through a flow control device and customers are required to provide onsite storage to cater for demand fluctuations.

Service Pipe

The section of water pipe between a water main and the point of supply.

Storage Tank

Any tank having a free water surface in which

water supplied by the Council is stored for use.

Supply Pipe

The section of pipe between the point of supply and the Customer's premises through which water is conveyed to the premises.

Water Alert Level

Classification system used for applying water conservation restrictions.

Water Carrier

Any individual drinking-water carrier or company registered with the Taumata Arowai as a recognised carrier of drinking- water.

Water Supply Network

All those components of the water supply system between the point of abstraction from the natural environment and the point of supply. This includes but is not limited to:

- (a) catchments, wells, infiltration galleries, intake structures, open raw water storage ponds/lakes/reservoirs, falling and rising mains, treatment plants, treated water reservoirs, trunk mains, service mains, rider mains, pump stations and pumps, valves, hydrants, scour lines, service pipes, boundary assemblies, meters, backflow prevention devices and tobies.

Water Unit

The basis of measurement for water supply as determined by the Council. One unit is equal to one cubic metre.

8. Protection of Water Supply Network

8.1. Water Supply Network

8.1.1. Access and connection to Network

- (a) No person other than the Council and its authorised agents shall have access to any part of the water supply network, unless with prior approval.
- (b) Except as set out in Clause 8.1.2 (Fire Hydrants), no person shall make any connection or interfere with any part of the water supply network, unless with prior approval.

- (c) Where the water supply network becomes contaminated due to unauthorised access, the Council may recover cost of remediation of contamination.
- (d) Any person causing damage which occurs to a Council water supply network during unauthorised access shall be liable for the cost of repair and any other costs the Council incurs as a result of the incident.

8.1.2. Fire Hydrants

- (a) No person may take water from a fire hydrant unless that person is:
 - i. taking the water for the purposes of firefighting and is a Fire and Emergency New Zealand personnel – as defined in the Fire and Emergency New Zealand Act 2017; or
 - ii. authorised to do so either by Council directly or through the granting of a permit in which case the taking of water is in accordance with any conditions attached to such approval.
- (b) Any person using a fire hydrant in breach of 8.1.2 (a) must immediately remove the standpipe when requested to do so by Council or their agent.
- (c) Any person using a fire hydrant pursuant to 8.1.2(a)(ii) is liable to Council for any damage or loss caused to the fire hydrant or the water supply network as a result of that use.
- (d) Without prejudice to other remedies available, the Council may seize and impound any equipment used by an offender to gain access to, or draw water from a fire hydrant, and assess and recover the value of water drawn without authorisation and any other associated costs.
- (e) Permit holders shall only use approved blue coloured metered standpipes and have two non-return valves to draw water from fire hydrants.

8.1.3. Working around Buried Services

- (a) No person shall carry out any excavation without first reviewing the Council's records of the location of its buried services to establish whether or not Council services are located in the vicinity of the proposed works. The Council may charge a fee for the provision of this information and does not guarantee the accuracy or completeness of such information.

- (b) Where appropriate the Council may in its absolute discretion mark out to within $\pm 0.5\text{m}$ on the ground the location of its services and nominate in writing any restrictions on the work it considers necessary to protect the integrity of the water supply network. The Council shall charge for this service.
- (c) All excavations within the road reserve is subject to the permit process of the appropriate road controlling authority.
- (d) The Council may require the independent supervision of works which may be in the vicinity of its buried services.
- (e) Every person excavating or working around the Council's buried water supply services shall take due care to ensure that the services are not damaged and that bedding and backfill is reinstated in accordance with the appropriate Council specification.
- (f) Any damage which occurs to the Council services shall be reported to the Council immediately. The person causing the damage shall be liable for the cost of repair and any other costs the Council incurs as a result of the damage.

Advisory Note: All excavation and trenching work carried out within the road corridor must be carried out in accordance with the National Code of Practice for Utility Operators' Access to the Transport Corridor.

8.2. Protection of Water Sources

8.2.1. Catchment Classes

Surface water and groundwater catchment areas from which untreated water is drawn for the purposes of water supply may be designated by Council as:

- (a) Controlled Catchment; or
- (b) Restricted Catchment; or
- (c) Open Catchment.

Advisory Note: These catchments are also subject to National Environmental Standards for Sources of Human Drinking Water.

8.2.2. Controlled Catchments

- (a) No person shall enter Controlled Catchments except those specifically authorised or permitted in writing by the Council.

- (b) Every person on any Controlled Catchment Area or land held by the Council as a water reserve will, upon demand, produce any such permit for inspection.
- (c) The Council may, at any time, by notice in writing, revoke or suspend any such permit for such time as may be stated in such notice.
- (d) No permit issued by Council may be transferred. Every person shall, upon the request of an authorised officer of the Council, immediately leave the controlled catchment area or land held by the Council as a water reserve.
- (e) No person shall obstruct or hinder any duly appointed officer of the Council in the exercise of any powers vested in that officer under this Bylaw.

8.2.3. Restricted Catchments

- (a) Certain activities are permitted within Restricted Catchment areas, such activities being limited to:
 - i. Tramping;
 - ii. Hunting;
 - iii. Trapping;
 - iv. Shooting; or
 - v. Fishing
- (b) No person may camp overnight in a Restricted Catchment area.
- (c) Every person shall, upon the request of an authorised officer of the Council, immediately leave the Restricted Catchment area.

8.2.4. Open Catchments

In open catchment areas whether designated or not, there will generally be no restriction on activities other than the provisions of the Regional or the District Plan and the National Environmental Standards.

8.2.5. Spillages and Adverse Events

- (a) In the event of a spillage, or any event which may compromise potable water or the water supply network, the person responsible for the event

shall advise the Council immediately. This requirement shall be in addition to those other notification procedures which are required for other authorities.

- (b) Where the owner or occupier of a premise allows or permits any item or items on the premises that may potentially contaminate or leach into the water supply and to accumulate on the premises contained within the catchment, the Council may request the owner or occupier to contain and remove the item or items using a Council approved method and location.
- (c) If the item(s) are not removed within the period specified, the Council or its authorised agents may remove the items and recover the costs from the Customer associated with containment, removal and disposal.

9. Conditions of supply

9.1. Connection, Disconnection and other works

- (a) No person shall, without Council's approval:
 - i. Connect to the water supply network;
 - ii. Disconnect from the water supply network;
 - iii. Carry out any other works on, or in relation to, the water supply network;
 - iv. Tamper with any, access point, valve on, or otherwise with the water supply network.
- (b) Any person wishing to connect to or disconnect from the water supply network, or to otherwise carry out works on such a network or change level of service or end use of water supplied or supply changes or increase supply, must make a written application for approval to Council on the prescribed form, and must provide with that application all information relating to the application as specified by Council.
- (c) Council may grant approval to such connection, disconnection or other works, as the case may be, and may impose conditions which must be complied with in the exercise of the approval.

The Council may require a Customer to enter into an individual Customer agreement and supply a Water Conservation and Demand Management Plan based on the Customer's water demand requirements.

- (d) Without limiting subclause 9.1(c), a condition imposed under that

subclause may require that the connection, disconnection or works comply with any relevant code of practice.

- (e) Council may refuse an application for approval to connect or disconnect to a network where:
- i. The applicant has not paid fees or charges associated with the connection (including development contributions) within 20 working days that have been required by Council to continue with installation, or has refused to provide such information relating to the application as has been specified by Council; or
 - ii. Council has a documented record of the applicant's non-compliance with this Bylaw or any previous water supply Bylaw, codes of practice, or approvals granted under such Bylaws or codes of practice; or
 - iii. in Council's reasonable opinion, there is insufficient capacity in the network to accommodate the connection; or
 - iv. in Council's reasonable opinion, the connection could compromise its ability to maintain levels of service in relation to the water supply including volume and/or pressure required for firefighting; or

Advisory Note: Refer to [SNZ PAS 4509: 2008 New Zealand Fire Service Fire Fighting Water Supplies Code of Practice](#) for acceptable volume and pressure levels.

- v. the connection is outside the area currently served by the water supply, regardless of its proximity to any specific component of the water supply; or
- vi. in Council's reasonable opinion, refusal is necessary to protect the water supply network, the health and safety of any person, or the environment.

9.2. Change of Use

- (a) An application shall be submitted to the Council for approval if a Customer seeks:
- i. a change in the level of service; or
 - ii. end use of water supplied to the premises; or
 - iii. a change in supply from ordinary to extraordinary (see clause 9.5)

or vice versa; or

- iv. a physical change of location or size.
- (b) Any application under this clause 9.2 shall be treated as a new application for the purposes of clause 9.1 of this Bylaw.

9.3. Point of Supply

9.3.1. Ownership and Responsibility for Maintenance

- (a) The Council shall own and maintain the service pipe and fittings up to the point of supply. The Customer shall maintain the supply pipe and fittings beyond the point of supply.

Advisory Note: The Council gives no guarantee regarding the serviceability of the valve located on the service pipe. Where there is no Customer stopcock, or where maintenance is required between the isolation valve and the Customer stopcock, the Customer may use the isolation valve to isolate the supply. However, the Council reserves the right to charge for maintenance of this valve if damaged by such Customer use.

- (b) The Customer shall maintain the area in and around the point of supply by keeping it free of soil, growth, or other matter or obstruction which prevents, or is likely to prevent, convenient access to the point of supply.
- (c) Unless otherwise specified in this Bylaw, change of ownership (between Council and Customer), of water supply pipes and fittings occurs at the point of supply.
- (d) The Customer shall be solely responsible for maintaining the proper position (open or closed) of the Isolation Valve, commonly referred to as the Toby, and ensuring it is correctly set at all times. If any additional water use occurs as a result of the Isolation Valve position, the cost of such use shall also be the responsibility of the Customer.

Advisory Note: The isolation valve is normally located at the front of the property under a blue or black plastic cover alongside the water meter.

9.3.2. Location

- (a) For each individual property there shall be only one point of supply, unless otherwise approved in writing by the Council. A point of supply shall be located in the position as shown in Schedule 1. Where fences, walls or other permanent structures make it difficult to locate it at the required position, the point of supply shall be located as close as possible

to the required position indicated in Schedule 1. The location of the point of supply in any position other than the required position shall require specific approval from Council. Any new point of supply shall be located outside the boundary of the premises in the position approved by the Council.

- (b) Existing points of supply may be located either inside or outside the property boundary. The Council may relocate the point of supply when deemed appropriate or on request from the Customer. The relocation of the point of supply, pipework and fittings from the new point of supply to the existing Customer supply pipe shall be the responsibility of the Council for six months from the time of relocation.

9.3.3. Multiple Ownership of Premises

Where the premises are held in multiple ownership, the point of supply shall be as follows:

- (a) In respect of company ownership for a company share/block scheme (Body Corporate), the point of supply shall be located as shown in Schedule 1 or as or as close as possible where fences, walls, or other permanent structures make it difficult to locate it at the required position, unless otherwise approved. Other positions shall require specific approval from Council.
- (b) For Leasehold/Tenancy in Common Scheme (Cross Lease), Strata Title, Unit Title and any other form of multiple ownership, each Customer shall have an individual supply with the point of supply determined by agreement with the Council. In specific cases other arrangements may be acceptable, subject to the Council's approval.
- (c) Where a bulk meter feeds multiple units, a unit title must be nominated by the company or body corporate (whichever is relevant) to hold the bulk meter for payment purposes.

9.4. Access to and about the Point of Supply

9.4.1. Rights of Access

- (a) Where the point of supply is on private property the Customer shall allow the Council access to the point of supply between 7.30am and 6.00pm on any day for:
 - i. Meter reading without notice being given.
 - ii. Checking, testing and maintenance work, with notice being given

when possible.

- (b) For works required outside the above hours (such as for night-time leak detection), the Council shall provide notice to the Customer.
- (c) If, after giving reasonable notice, an authorised agent is prevented from accessing the point of supply at any of the above times and a return visit is required, a fee may be charged in accordance with the fees and charges. Where the point of supply is on private property the Customer shall allow the Council access to the point of supply between 7.30am and 6.00pm on any day.
- (d) In accordance with section 173 of the Local Government Act 2002, where there is an emergency, the Council shall enter the property without notice and the Customer shall allow the Council unobstructed access to, and about the point of supply at any hour.

9.5. Types of Water Supply

9.5.1. General

Water supplies shall be classified as either 'on demand' or 'restricted flow' and the use of water from the supply shall be either 'ordinary' or 'extraordinary'.

9.5.2. On Demand Supply

- (a) All premises situated within the on demand water supply area shall be entitled to an ordinary supply of water subject to:
 - i. Any restrictions on water use made by the Council under clause 9.8.1 of this Bylaw;
 - ii. Payment of the appropriate charges in respect of supply to that premises;
 - iii. Any other charges or costs associated with subdivisional development; and
 - iv. Any other relevant conditions in section 8 of this bylaw.
- (b) Any premises which are located within the on- demand water supply area but do not connect to the public water supply may still be charged an availability charge in accordance with Council's fees and charges.
- (c) The Council shall be under no obligation to provide an extraordinary supply of water (see also the provisions of clause 9.8.1 of the Bylaw).

- (d) The Council shall charge customers for the provision of the on-demand supply by either:
- i. A targeted rate based on rating unit; or
 - ii. The volume passing through a meter per cubic metre; or
 - iii. Both (i) and (ii) – These charges are as set by the Council.
- (e) For premises which use a fire protection system complying with SNZ PAS 4509: 2008, in order for that use to be classified as ordinary, the Customer shall comply with the conditions set under clause 9.8.

9.5.3. Restricted Flow Supply

- (a) Restricted flow supply shall be available to premises in restricted supply areas under special conditions set by the Council. Customers receiving a restricted flow supply shall make provision for onsite water storage of a minimum volume of 22m³ or equivalent of at least 48 hours of average water use where this is greater than 22m³.
- (b) This may include for the purposes of:
- i. Rural supply within district; or
 - ii. Water demand management (including for drought, misuse and non-remedy of water leaks); or
- (c) The water supply shall be restricted so as to deliver 1.8m³ per day or the agreed number of water units at a steady flow rate through a water meter.
- (d) The Council shall charge for the restricted supply by:
- i. A targeted rate based on rating unit; or
 - ii. The volume passing through a meter per m³; or
 - iii. Both (i) and (ii) – These charges are as set by the Council.
- (e) All restricted supply storage tanks must include a suitable, testable backflow prevention device located at the boundary of the property.
- (f) Properties identified without flow restrictors in restricted supply areas may be given twelve weeks written notice to install onsite water storage

of a minimum volume of 22 cubic metres or the equivalent of at least 48 hours of average water use where this is greater than 22 cubic metres. After this period Council shall install the appropriately sized flow restrictor.

- i. Any property owner who receives written notice may make a written application within 10 working days of receiving such notice for an exemption.
 - ii. Matters which will be taken into account when assessing an application for exemption include (but are not limited to):
 - Location of the property;
 - The basis on which the exemption is claimed;
 - Any other matter which the Council deems relevant.
- (g) Owners are allowed to transfer water allocations subject to following conditions:
- i. The initial property retains a 1.8 cubic metre allocation;
 - ii. The transfer has to take place within the same water supply;
 - iii. The new property to which water allocation is transferred or sold has to be located at a place where the Council is able to supply the allocation without further upgrading or extension works;
 - iv. If upgrading or extension works are required then the Customer transferring the allocation has to pay up-front for the full cost of the upgrading or extension works; and
 - v. The Customer transferring the allocation has to pay for the connection cost to the new property and a transfer fee.
- (h) Council allows property owners to apply for disconnection from the restricted water supply. No refund either in part or whole of any development contribution will be made. Such an application must state the alternative water source the consumer will rely on. Council charges those property owners a disconnection fee to recover costs of effecting the disconnection. Should the owner wish to reconnect to a Council water scheme, reconnection fees will be charged.

Advisory Note: The Council gives no guarantee regarding the serviceability of the valve located on the service pipe. Where there is no (Owner) stopcock or where maintenance is required between the isolation valve and the (Owner) stopcock, the (Owner) may use the isolation valve to

isolate the supply in an emergency. However, Council reserves the right to charge for maintenance of this valve if it is damaged by the (Owner) during use for this purpose.

9.6. Meters and Flow Restrictors

All water connections in Waikato District shall be metered.

9.6.1. Installation of meters

- (a) Meters for on demand supplies, and restrictors for restricted flow supplies shall be supplied, installed and maintained by the Council, and shall remain the property of the Council.
- (b) The Council may fit a meter to any connection on any Premises at any time for the purposes of determining water consumption.
- (c) The Council may fit additional meters to any minor or ancillary dwelling located on any Premises, for the purposes of determining water consumption.
- (d) Where a premises is supplied with an on demand water supply and is not metered, the Council reserves the right to fit a meter at the Customers cost and charge accordingly.

Advisory Note: Clauses 9.6.1 (a) to (d) shall only apply to properties which have a connection to the water supply network.

9.6.2. Location

Meters and restrictors shall be located in a position where they are readily accessible for reading and maintenance, and if practicable immediately on the Council side of the point of supply.

9.6.3. Accuracy

- (a) Meters shall be tested as and when required by the Council.
- (b) The flow restrictors shall be accurate to within $\pm 10\%$ of their rated capacity.
- (c) Any Customer who disputes the accuracy of a meter or restrictor may apply to the Council for it to be tested provided that the testing is not requested within six months of any previous test. If the test shows the meter is accurate, the Customer shall pay a fee in accordance with the Council's fees and charges. A copy of independent certification of the test

result shall be made available to the Customer on request.

- (d) Restrictors shall be tested by measuring the quantity of water that flows through the restrictor within a period of not less than one hour, at the expected minimum operating pressure.

9.6.4. Adjustment

- (a) If a test is carried out and the meter is found to register a consumption which is different to the quantity of water which has actually passed through the meter, the Council shall make an adjustment in accordance with the results shown by such tests, backdated for a period determined by the Council but not exceeding 12 months, and the Customer shall pay a greater or lesser amount according to the adjustment.
- (b) Where a meter is under-reading by more than 20% or has stopped, the Council reserves the right to charge for the amount of water assessed as having been used over the past billing period, taking into account any seasonal variations in water demand, and charge the customer accordingly.
- (c) Where a meter is over-reading, the Council shall make appropriate adjustments to the Customer's account, based on a period of similar use and backdated to when it is agreed the over-reading is likely to have occurred.

9.6.5. Estimating Consumption

- (a) Where a meter is damaged, ceases to register, has been removed or where the seal or dial of the meter is broken, or the meter has otherwise been interfered with, the Council shall estimate the consumption for the period since the previous reading of such meter, (based on the average of the previous four billing periods charged to the Customer) and the Customer shall be liable for the amount estimated.
- (b) If the average of the previous four billing periods would be an unreasonable estimate of the consumption (due to seasonal or other causes), the Council may consider other evidence for the purpose of arriving at a reasonable estimate, and the Customer shall pay according to such an estimate.
- (c) Where the Customer is a non-profit organisation, and the meter indicates a significant increase in consumption, and it is established that the increase is caused by a previously unknown leak, the Council may estimate consumption as provided for in clause 9.6.5 (a) providing that the Customer repairs the leak as soon as is practicable.

- (d) Where an unauthorised connection has been made to the Council's water supply network, the Council will estimate the consumption for the period from when the connection was made, using the uniform charge for water on a pro rata basis. Where a meter has been installed without approval, and such meter complies with Council's standards for meters and installation, the full consumption registered on the meter shall be payable by the current occupier of the premises. Payment of the estimated charge does not preclude Council from taking any other enforcement action available to it.

9.6.6. Incorrect Accounts

- (a) Where a situation occurs, other than as described in clause 9.6.5, and the recorded consumption does not accurately represent the actual consumption on a property, the account shall be adjusted using the best information available to the Council. Such situations include, but are not limited to, misreading of the meter, errors in data processing, meters assigned to the wrong account, and unauthorised water supplies.
- (b) Where an adjustment is required in favour of the Council or the Customer, the adjustment shall not be backdated more than 12 months from the date the error was detected.

9.6.7. Leaks

- (a) It is the Customer's responsibility to detect and fix all leaks from taps and pipes, stop overflows from cisterns, hot water cylinder exhausts or stock troughs. If a leak is visible from fixtures and is not repaired, no leak relief remission will be available.
- (b) Relief may be available, at Council's discretion for leaks which are undetected.
- (c) Any Customer wishing to apply for relief must make such application in writing in accordance with Council's Water Leak Remission Policy.

9.7. Levels of Service and Continuity of Supply

- (a) Although Council shall make all endeavors to provide water in accordance with the level of service set out in Schedule 2, due to practical and physical limitations, the Council cannot guarantee an uninterrupted or constant supply of water in all circumstances, or the continuous maintenance of any particular water pressure.
- (b) Where planned permanent or temporary works will affect an existing

supply, the Council shall inform or give notice to all Customers who, in the opinion of Council, are likely to be substantially affected.

- (c) If a Customer has a particular requirement for an uninterrupted level of service (flow, pressure, or quality), it shall be the responsibility of that Customer to provide any storage, back-up facilities, or equipment necessary to provide that level of service.

9.8. Demand Management

- (a) Where required by rules in a District Plan, owners must maintain devices that have been installed for the purposes of water demand management and in accordance with an associated integrated catchment management plan.

9.8.1. Water Alert and Emergency Restrictions

- (a) In circumstances where natural hazards (such as floods, droughts or earthquakes) or accidents result in disruptions to the supply of water, Council may declare a water alert level or an emergency for the purposes of the supply of water and shall be exempt from the levels of service requirements.
- (b) During a water alert and/or emergency the Council may restrict or prohibit the use of water for any specified purpose or period, and for any or all of its Customers. Such restrictions shall be advised by public notice. The Customer shall comply with any restrictions imposed by Council, until such time as Council advises the restrictions are no longer in place.
- (c) The Council may, after serving notice and taking all practicable steps to contact a Customer, restrict and or meter the supply to reduce unnecessary and unauthorised water use and wastage where it deems necessary.

9.8.2. Maintenance and Repair

- (a) In circumstances where a scheduled maintenance shutdown of the supply is required, Council shall make all practicable attempts to notify Customers prior to any work commencing. Where Council is unable to notify the Customer, or immediate action is required, the Council may restrict the supply without notice.
- (b) Where a Customer has assets restricting the maintenance of a Council water supply network, the Council shall not be responsible for damage caused to the asset in order to maintain the Council water supply network.

- (c) If Council must carry out repairs or maintenance to privately owned supply pipes and/or water assets, the costs of such repairs or maintenance may be recovered from the Customer responsible for the pipes and/or assets.

9.9. Liability

The Council shall not be liable for any loss, damage or inconvenience incurred by a Customer (or any person using the supply) because of a reduced level of service of, or interruptions to the water supply.

9.10. Fire Protection Connection

9.10.1. Connection Application

An application to install a connection for fire protection purposes must be made, in writing, to the Council. Council may impose any conditions it determines are appropriate.

9.10.2. Design of Fire Protection Systems

As part of the application to install a connection for fire protection purposes, the Customer shall demonstrate to the Council that the available supply is adequate for the intended purpose. It shall also be the Customers responsibility to monitor the supply to ensure it continues to be adequate for the intended purpose.

Advisory Note: For further information on fire safety water sprinkler or storage requirements refer to the [SNZ PAS 4509: 2008 New Zealand Fire Service Fire Fighting Water Supplies Code of Practice](#). Customers may also wish to consult with the New Zealand Fire Service Fire and Emergency New Zealand about suitable measures to provide firefighting protection for their properties.

9.10.3. Fire Protection Connection Metering

- (a) Where a fire connection has been installed (or located) so that it is likely or possible that water may be drawn from it by any person for purposes other than firefighting, the Council may charge for the usage.
- (b) Where the supply of water to any premises is metered, fire hose reels shall be connected only to the metered supply, not to the fire protection system. The water supply to fire hose reels shall comply with the requirements of NZS 4503:2005 Hand operated fire-fighting equipment.
- (c) Water used for the purpose of extinguishing fires shall be supplied free

of charge. Where the fire protection connection is metered, and water has been used for firefighting purposes, the Council shall estimate the quantity of water used, and credit to the Customer's account an amount based on such an estimate.

- (d) Owners intending to test fire protection systems in a manner that requires a draw-off of water must obtain the approval of the Council beforehand. Water used for routine flushing and flow testing does not constitute waste, but the quantity of water used may be assessed and charged for by the Council.

9.11. Backflow Prevention

9.11.1. Customer Responsibility

It is the Customer's responsibility to take all necessary measures on the Customer's side of the point of supply to prevent water which has been drawn from the Council's water supply from returning to that supply. All necessary measures shall include:

- (a) Backflow prevention either by providing an adequate air gap, or the use of an appropriate backflow prevention device; and/or
- (b) The provision for the exclusion of any cross-connection between the Council water supply and:
 - i. Any other water supply (potable or non-potable)
 - ii. Any other water source
 - iii. Any storage tank
 - iv. Any other pipe, fixture or equipment containing chemicals, liquids, gases, or other non-potable substances.

Advisory Note: Fire protection systems that include appropriate backflow prevention measures would generally not require additional backflow prevention, except in cases where the system is supplied by a non-potable source or a storage tank or fire pump that operates at a pressure in excess of the Council's normal minimum operating pressure.

Advisory Note: The type of back flow prevention device to be used is dependent on the risk to the water supply posed by the Customer.

9.11.2. Unmanaged Risk

Where a Customer is unable to demonstrate that the risk of backflow is adequately managed or fails to take all necessary measures as required in clause 9.11.1 of the Bylaw, the Council may undertake the required works and fit a backflow prevention device on the Council side of the point of supply. In accordance with section 186 of the Local Government Act 2002, Council may recover such costs as a debt from the Customer.

Council will undertake a periodic surveying of existing connections to determine integrity and suitability of the backflow prevention device installed from each point of supply.

Advisory Note: Testable backflow prevention devices, require annual testing by a qualified or Council approved contractor. A test report shall be submitted to the Council for the Customer owned devices.

9.12. Council Equipment and Inspection

9.12.1. Care of Water Supply Network

The Customer of the premises shall not damage or tamper with any part of the water supply network, including but not limited to pipe-work, valves, meters, restrictors, chambers, and backflow prevention devices. Should any damage occur which requires repairs, the Council reserves the right to recover the cost of such damage and/or repairs as a debt from the Customer.

9.12.2. Inspection

In accordance with section 182 of the Local Government Act 2002, the Customer shall allow the Council or its agents, with or without equipment, access to any area of the premises for the purposes of determining compliance with this Bylaw.

9.13. Plumbing System

9.13.1.

The Customer's plumbing system shall be designed, installed and maintained, both in its component parts and its entirety, to ensure it complies with the Regional Infrastructure Specifications (RITS) or its amendments, Building Act 2004 and the New Zealand Building Code and is compatible with the water supply service as listed in Schedule 2.

9.13.2.

Quick-closing valves, pumps, hydraulically driven equipment or any other equipment which may cause pressure surges or fluctuations to be transmitted

within the water supply network or compromise the ability of the Council to maintain its stated levels of service, shall not be used on any piping beyond the point of supply. In special circumstances such equipment may be approved by the Council at its discretion. A gate valve shall not be used to control the water supply flow to the premises.

9.14. Prevention of Water Loss and Waste

9.14.1.

The Customer shall not allow water to run to waste from any pipe, tap, or other fitting, nor allow the condition of the plumbing within the premises to deteriorate to the point where leakage or wastage occurs.

9.14.2.

Water is provided by the Council for consumption purposes only. The Customer shall not use water or water pressure directly from the supply for driving lifts, machinery, educators, generators, or any other similar device, unless specifically approved by the Council.

9.14.3.

The Customer shall not use water for a single pass cooling system or to dilute trade waste prior to disposal, unless specifically approved by the Council.

9.14.4.

Where a Customer ignores advice from the Council to repair an on-going leak, the Council may after serving notice, repair the leak and charge the Customer all associated cost as provided in the Local Government Act 2002.

Advisory Note: The Waikato District Plan sets out water saving measures required for water supply connections.

9.15. Payment

9.15.1.

The Customer shall be liable to pay for the supply of water and related services in accordance with the Council's rates, fees and charges prevailing at the time.

9.15.2.

The Council may recover unpaid water rates in respect of the supply of water as prescribed in the Local Government (Rating) Act 2002 from the owner of a

premises, the occupier of a premises, or both.

9.16. Transfer of Rights and Responsibilities

9.16.1.

The Customer shall not transfer to any other party the rights and responsibilities set out in this Bylaw.

9.17. Change of Ownership

9.17.1.

In the event of a premises changing ownership the new owner will be recorded as the customer at those premises from the date of notification. Where the premises are metered, the outgoing Customer shall give the Council ten working days' notice to arrange a final meter reading.

9.17.2.

The Council reserves the right to reassess the conditions of supply when a change of ownership occurs.

9.17.3.

The owner of the premises at the time of the consumption is responsible for any water charges.

9.18. Disconnection at the Customer's Request

The Customer shall give 10 working days' notice in writing to the Council of a requirement for disconnection of the supply. Disconnection shall be at the Customer's cost.

10. Breaches

10.1. Breaches of conditions of supply

10.1.1

The following are deemed to be breaches of the conditions to supply water:

- (a) An incorrect application for supply which fundamentally affects the conditions of supply;
- (b) Failure to meet any obligations placed on the Customer under all Codes

and Standards specified in this Bylaw;

- (c) An act or omission including but not limited to any of the following:
- i. Any tampering or interference with Council equipment/assets, either directly or indirectly;
 - ii. Failure to pay the appropriate charges by the due date;
 - iii. Frustration of the Council's ability to adequately and effectively carry out its obligations;
 - iv. Failure to repair a leak, or in any way willfully allowing water to run to waste, or to be misused;
 - v. The fitting of quick-closing valves, pumps, or any other equipment which may cause pressure surges or fluctuations to be transmitted within the water supply network, or compromise the ability of the Council to maintain its stated levels of service (subject to clause 9.5 of this Bylaw);
 - vi. Failure to prevent backflow;
 - vii. Failure to maintain or inspect backflow;
 - viii. Using water or water pressure directly from supply for driving lifts, machinery, educators, generators, or any other similar device, unless specifically approved by the Council;
 - ix. Using water for a single pass cooling or heating system, or to dilute trade waste prior to disposal, unless specifically approved;
 - x. Extending by hose or any other pipe a private water supply beyond that Customer's property;
 - xi. Providing water drawn from the Council supply to any other party without approval of the Council;
 - xii. Unauthorised removal of flow restrictors.
- (d) Every person commits a breach of this Bylaw and commits an offence who:
- i. Does, permits or allows anything to be done, which is contrary to this Bylaw;

- ii. Fails to do or perform any act, or thing, that they are required to do by this Bylaw, within the time and in the manner required by the Bylaw, or any part of it;
- iii. Commits any breach of the terms and conditions of this Bylaw;
- iv. Does anything prohibited by this Bylaw;
- v. Fails to comply with any notice given under this Bylaw or any part of it or any condition that is part of any notice granted by the Council;
- vi. Where required, fails to obtain written approval or having obtained written approval fails to abide by the conditions (if any);
- vii. Obstructs or hinders any authorised officer in the performance of any duty or in exercising any power conferred by this Bylaw;
- viii. Tampers or interferes with any part of the Council owned water supply network without a permit;
- ix. Withdraws water from a fire hydrant without authorisation from the Council for any other purpose than fire protection;
- x. Fails to comply with water use restriction or prohibitions introduced by the Council for any specific purpose;
- xi. Fails to meet any obligations placed on the Customer through any permit conditions;
- xii. Fails to meet any obligations placed on the Customer through an individual Customer agreement;
- xiii. Other than the Council or its authorised agents, who accesses the water supply network without a valid permit breaches this Bylaw.

10.1.2

In the event of a breach of any provision of this Bylaw, the Council shall serve notice on the Customer advising the nature of the breach, the steps to be taken, and required timeframe to remedy the breach to the satisfaction of the Council beyond timeframe indicated. If the Customer persists with the breach the Council reserves the right to:

- (a) Reduce the flow rate of water to the Customer without notice. Reinstatement of full supply shall be re-established only after the Customer completes payment of the appropriate fee and remedy of the

breach to the satisfaction of the Council.

- (b) Install a water meter. The Customer will also be charged for the ongoing supply of water as per Council's fees and charges for water supply as determined by Council from time to time.
- (c) For extraordinary supply – disconnect the water supply for all purposes other than domestic water use.
- (d) If the breach is such that the Council is required to disconnect the supply for health or safety reasons, disconnection may occur immediately and without further notice to the Customer.

10.2. Interference with equipment

Any tampering or interfering with Council equipment, either directly or indirectly, shall constitute a breach of this Bylaw.

11. Offences and Penalties

A person who fails to comply with the requirements of this Bylaw commits a breach of this Bylaw and is liable to a penalty under the Local Government Act 2002.

12. Schedules

The following schedules can be amended through a Council resolution.

Schedule 1: Examples showing Single/Manifold Connection

Schedule 2: Table 1 Compatibility Features

Schedule 3: Water Supply Area Maps

13. General

Any notice, order or other document which is required by this Bylaw to be served or given or sent to any person shall be deemed to have been duly served given or sent if delivered to such person or left at his or her residence or workplace or posted to such person at his or her last known address.

Any resolution of the Council may be amended, rescinded or reinstated by a further resolution of the Council.

This Bylaw was made pursuant to a resolution passed by the Waikato District Council on [To be inserted].

THE COMMON SEAL of WAIKATO DISTRICT COUNCIL was hereto affixed in the presence of:

Mayor

Chief Executive

Activity	Key Date	Council resolution
Bylaw made	[To be inserted]	[To be inserted]
Bylaw reviewed		
Next review due date		

Schedule 1: Examples showing Single/Manifold Connection

Example 1: With Street Frontage

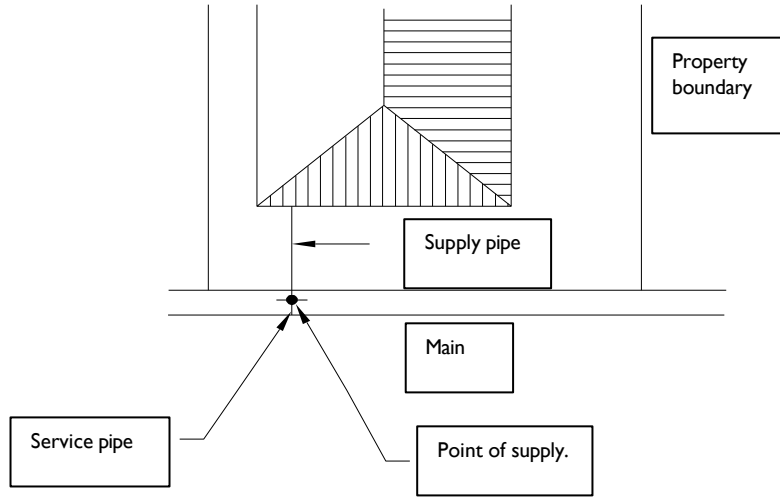

Figure 1: Point of supply outside property boundary

Example 2: Rear lots on right of way (up to 2 customers)

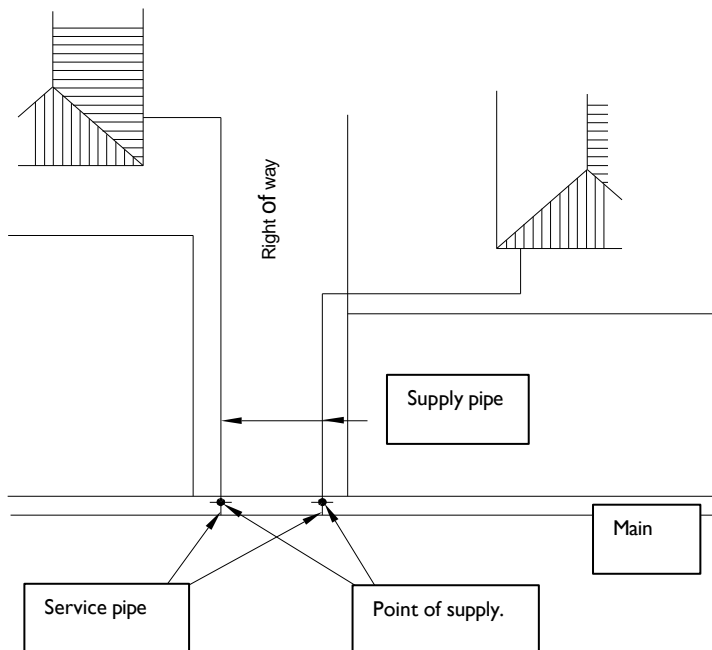

Figure 2: Point of supply outside property boundary

Example 3: Rear lots on right of way (3 or more customers)

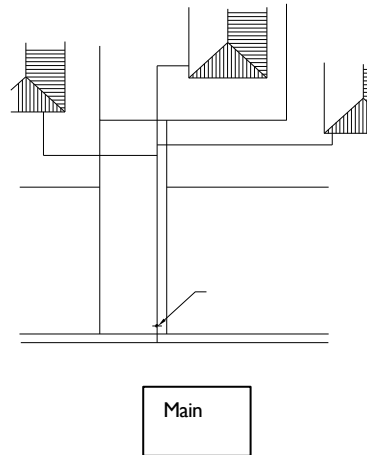
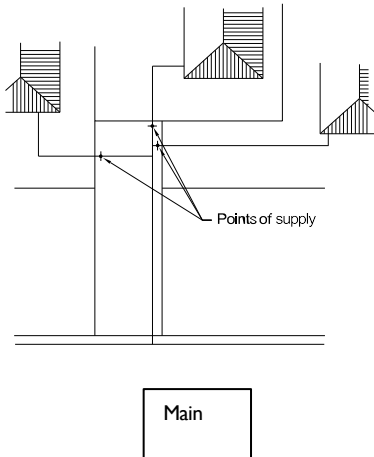

Figure 3: Point of supply outside property boundary

Figure 4: Common point of supply

Example 4: Industrial, commercial, domestic fire and service connections including schools)

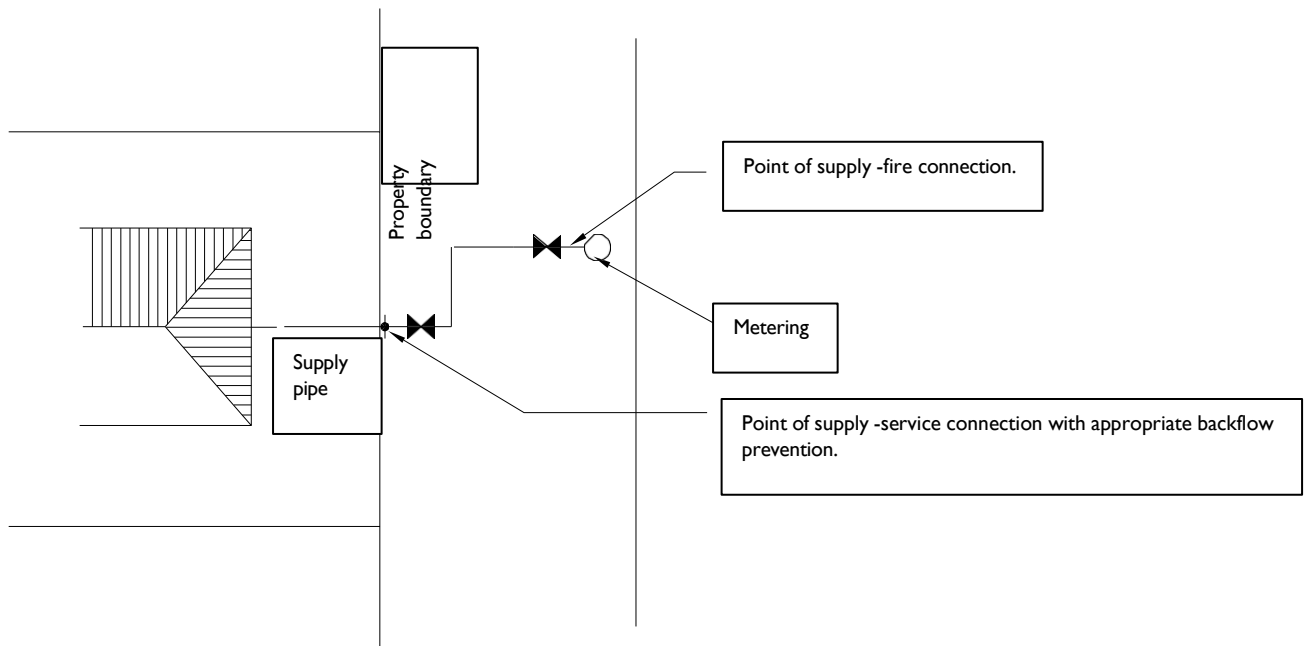

Figure 5: Combined fire and service connection

Advisory Note: Refer to SNZ PAS 4509: 2008 New Zealand Fire Service Fire Fighting Water Supplies Code of Practice for guidance on appropriate fire supply connection location.

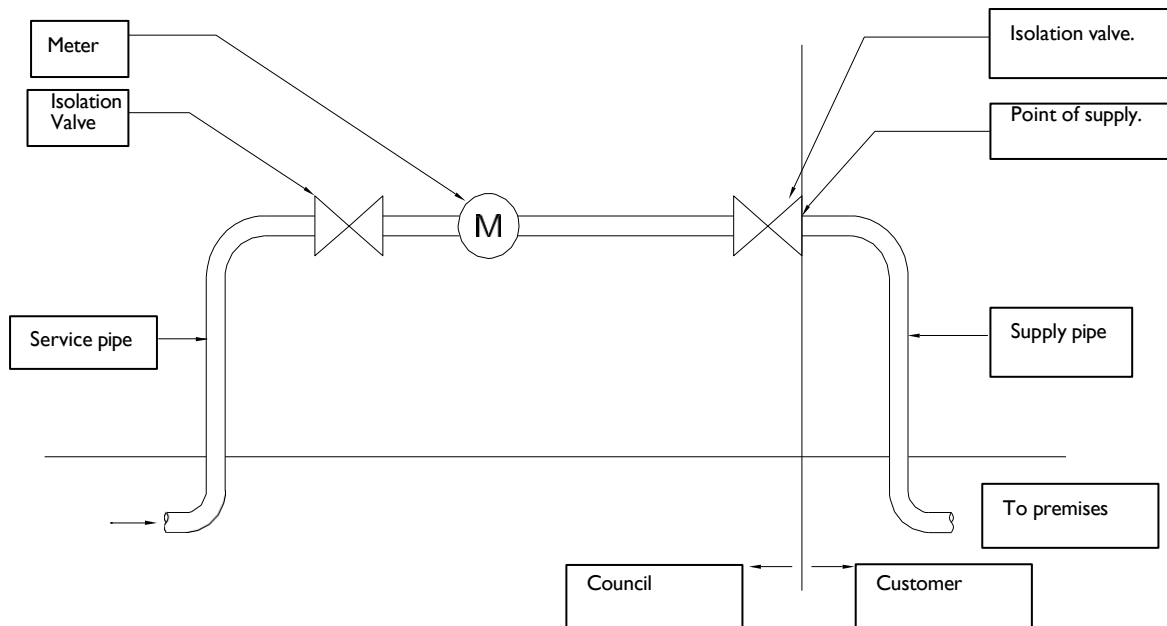

Figure 6: Domestic metered supply

Note:

1. Point of supply is tail piece of boundary box, meter, or isolation valve regardless of property boundary.
2. The New Zealand Building Code may require the Customer to install additional backflow prevention devices within the site, which will remain the responsibility of the Customer.

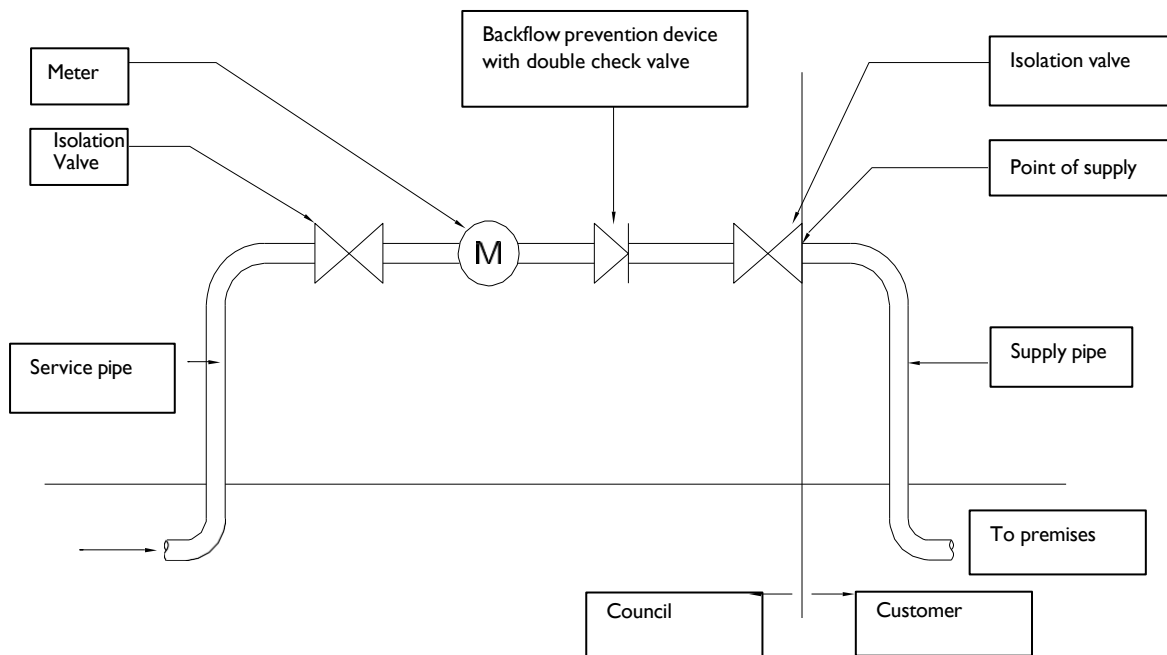

Figure 7: Metered supply with backflow prevention device owned by Council

Note:

1. Point of supply is tail piece of boundary box, meter, or isolation valve regardless of property boundary.
2. The New Zealand Building Code may require the Customer to install additional backflow prevention devices within the site, which will remain the responsibility of the Customer.

Schedule 2: Table 1 Compatibility Features

Specific features of the Council supply which need to be taken into account are contained in Table 1 below.

Table 1: Compatibility features

Feature	Value
Maximum operating pressure	100 metres head (1, 000 kPa)
Minimum operating pressure*	20 metres head (100 kPa)
Normal operating pressure	30 – 40metres head (200 - 300 kPa)
Free available chlorine	Up to 1.5 g/m ³
Min operating pressure (for rural supplies)	10 meters head (100 kPa)

**Minimum pressure refers to on demand water supplies only*

Schedule 3: Water Supply Area Maps

Pokeno

<https://waikatodc.spatial.t1cloud.com/spatial/intramaps/?project=Public&module=Utilities&configId=e6b2fca7-5d63-4aed-b49c-c32dc8cb1002&startToken=6ee29987-d21a-4765-9f52-ed1f51e620e2>

Raglan, Te Akau, Western Districts & Onewhero

<https://waikatodc.spatial.t1cloud.com/spatial/intramaps/?project=Public&module=Utilities&configId=e6b2fca7-5d63-4aed-b49c-c32dc8cb1002&startToken=0f63eb87-3a54-4580-8bba-8dbfe04db53d>

Ngaaruawaahia, Taupiri & Hopuhopu

<https://waikatodc.spatial.t1cloud.com/spatial/intramaps/?project=Public&module=Utilities&configId=e6b2fca7-5d63-4aed-b49c-c32dc8cb1002&startToken=e78963c8-bdcb-4b3a-8a5a-e62e601ef967>

Huntly

<https://waikatodc.spatial.t1cloud.com/spatial/intramaps/?project=Public&module=Utilities&configId=e6b2fca7-5d63-4aed-b49c-c32dc8cb1002&startToken=e19282d9-22b6-4a6d-939a-b02c85e2539d>

Southern Districts

<https://waikatodc.spatial.t1cloud.com/spatial/intramaps/?project=Public&module=Utilities&configId=e6b2fca7-5d63-4aed-b49c-c32dc8cb1002&startToken=639f77f4-2657-42a1-8502-8ab72db49071>

Te Kauwhata and Surrounds

<https://waikatodc.spatial.t1cloud.com/spatial/intramaps/?project=Public&module=Utilities&configId=e6b2fca7-5d63-4aed-b49c-c32dc8cb1002&startToken=324a9778-4b44-4938-891e-97454262fef2>

Tuakau

<https://waikatodc.spatial.t1cloud.com/spatial/intramaps/?project=Public&module=Utilities&configId=e6b2fca7-5d63-4aed-b49c-c32dc8cb1002&startToken=3fec4d6-c5aa-468e-a672-9cc0aeb499d4>

Port Waikato

<https://waikatodc.spatial.t1cloud.com/spatial/intramaps/?project=Public&module=Utilities&configId=e6b2fca7-5d63-4aed-b49c-c32dc8cb1002&startToken=cfc4af0a-72da-443b-8885-4450b5bdee3d>

To	Waikato District Council
Report title	Waters Governance Board Recommendations – 28 November 2023
Date:	Tuesday, 5 December 2023
Report Author:	Elizabeth Saunders, Senior Democracy Advisor
Authorised by:	Gaylene Kanawa, Democracy Manager

1. Executive summary

Whakaraapopototanga matua

The purpose of this report is to seek the Council's approval of the recommendations from the Waters Governance Board meeting held on 28 November 2023.

The Waters Governance Board agenda and attachments from the meeting on Tuesday, 28 November 2023 can be found on the Council website via the following link:

https://www.waikatodistrict.govt.nz/docs/default-source/meetings/agenda-2023/wgb-open-agenda-231128.pdf?sfvrsn=d12c6ac8_1

2. Staff recommendations

Tuutohu-aa-kaimahi

Port Waikato Flood Resilience Works (WGB2311/06)

THAT the Waters Governance Board recommends that Council:

- a. approve the reallocation of funds from account codes 104670.1700.0000.00.25407 and 102623.1700.0000.00.25407 to be used towards the Port Waikato Three-Waters Resilience Fund; and**
 - b. supports the Council funding obligations to this project.**
-

TKWA resource consent renewal update (WGB2311/08)

For Council information only.

THAT the Waters Governance Board:

- a. receives this report, and**
- b. notes that the Chief Executive will arrange that tankered potable water delivered by TKWA to Nga Muka Development Trust five marae during summer, is not charged up to 120m³/year and for a period of three years.**
- c. meets the requirement of Te Mata Arowai for a water carrier with regards to water cartage.**

3. Attachments

Ngaa taapirihanga

Link to the Open Waters Governance Board Agenda:

https://www.waikatodistrict.govt.nz/docs/default-source/meetings/agenda-2023/wgb-open-agenda-231128.pdf?sfvrsn=d12c6ac8_1

To	Waikato District Council
Report title	Infrastructure Committee Recommendations – 13 December 2023
Date:	Friday, 8 December 2023
Report Author:	Robyn Chisholm, Senior Democracy Advisor
Authorised by:	Gaylene Kanawa, Democracy Manager

1. Executive summary

Whakaraapopotanga matua

The purpose of this report is to seek the Council's approval of the recommendations from the Infrastructure Committee meeting to be held on Wednesday, 13 December 2023.

At the time of writing this report the staff recommendations in Open Agenda items 6.4 Proposed Community Waste Minimisation Fund and 6.8 Recovery Works Update – Storm Damage Repairs have not yet been considered by the Infrastructure Committee.

The Infrastructure Committee Open agenda and attachments for the meeting to be held on Wednesday, 13 December 2023 can be found on the Council website via the following link:

https://www.waikatodistrict.govt.nz/docs/default-source/meetings/agenda-2023/231213-inf-open-agendaa1c6c862-676e-4515-b6d5-82e5848c0f96.pdf?sfvrsn=23b76dc8_1

2. Staff recommendations

Tuutohu-aa-kaimahi

Proposed Community Waste Minimisation Fund

THAT the Infrastructure Committee recommends to Council:

- a. the establishment of a Community Waste Minimisation Fund as recommended in the Council's Waste Minimisation and Management Plan, and**
 - b. that the fund commences with an amount of \$50,000 in the first year, up to \$100,000 in the second year and up to \$150,000 in the third year.**
-

Recovery Works Update – Storm Damage Repairs

THAT the Infrastructure Committee recommends that Council:

- a. delegates authority to the Chief Executive to award emergency works packages up to the value of \$5.262M, and**
- b. notes that an additional report will be presented to the Infrastructure Committee in 2024 to provide details of contracts awarded.**

3. Attachments

Ngaa taapirihanga

There are no attachments.

To	Waikato District Council
Report title	Zero Harm Update
Date:	5 December 2023
Report Author:	Lynn Shirley, Zero Harm Manager
Authorised by:	Gavin Ion, Chief Executive

1. Purpose of the report

Te Take moo te puurongo

To provide Council with an update on the delivery of activities detailed in the Zero Harm Strategic Improvement Plan and overview current health and safety performance.

2. Executive summary

Whakaraapopototanga matua

- The planned migration from our existing version of BWare Safety Manager to a newer version has been delayed to early 2024.
- We continue to progress reviewing the risk control plans for Workplace Violence and On Road Driving and developing the risk control plan for Work-related Mental Wellbeing.
- The independent review and risk assessment of our security control measures for managing the critical risk of workplace violence will take place in mid-December.

3. Staff recommendations

Tuutohu-aa-kaimahi

That the Waikato District Council receives the Zero Harm report for December 2023 and the Zero Harm Performance Dashboard for November 2023.

4. Background

Koorero whaimaarama

Councils' zero harm culture is supported by a health and safety management system of policies, standards, requirements, and guidelines that are designed to support the elimination or management of risk and enable good practice.

5. Discussion Matapaki

Zero Harm Strategic Improvement Plan FY23/24 Progress

We continue to focus on the delivery of activities detailed in our FY23/24 Zero Harm Strategic Improvement Plan. We will be completing a review of Quarter 2 performance (October to December) prior to Christmas.



Our People

Worker Engagement, Participation and Consultation

The Safety Action Team (SAT) recently held their last meeting for 2023. Key areas of focus for the SAT remain:

- Supporting the organisation of Work Safe Home Safe (WSHS) 2024
- Developing new and updating existing tools to support SAT representative engagement and involvement
- Supporting the development of a digital risk assessment tool to use when undertaking property, site, or field visits

Over the last two months nine SAT representatives have also attended a Mental Health First Aid training course to deepen their knowledge of this critical risk.

Effective Systems

Auditing and Assurance

We are continuing to support the Animal Control team with implementation of improvement actions identified in the recent Critical Control Verification Assessment for the critical risk of Working with Animals. We have scheduled the next verification assessment for late January 2024.

Health and Safety Incident Management Software

We have been working with the support of a project manager, to transition from our existing version of BWare Safety Manager to an updated version that meets Council's Cloud System Cyber Security requirements. We had planned for this migration to be completed prior to Council's Christmas change freeze date. However, due to ongoing contract negotiations, the transition will now occur in early 2024.

Contractor Management

We are finalising our Zero Harm Safety Management System (ZHSMS) Health and Safety in Procurement (Contractor) Management Standard. Following a trial, two new tools have been implemented for undertaking on-site monitoring of contracted work. These have been incorporated into the relevant Procurement processes in Promapp. We will be engaging with the Contracts and Partnering Team to determine the best way to educate Contract Managers in the use of these tool.

Work is also planned to commence in early 2024, on developing a Contractor Health and Safety Handbook. The purpose of this handbook is to help Council contractors understand our health and safety expectations, and how we want to work together to consult, cooperate and coordinate on health and safety risk management.

The below dashboard illustrates the health and safety reporting for October and November from our Tier One contractors.

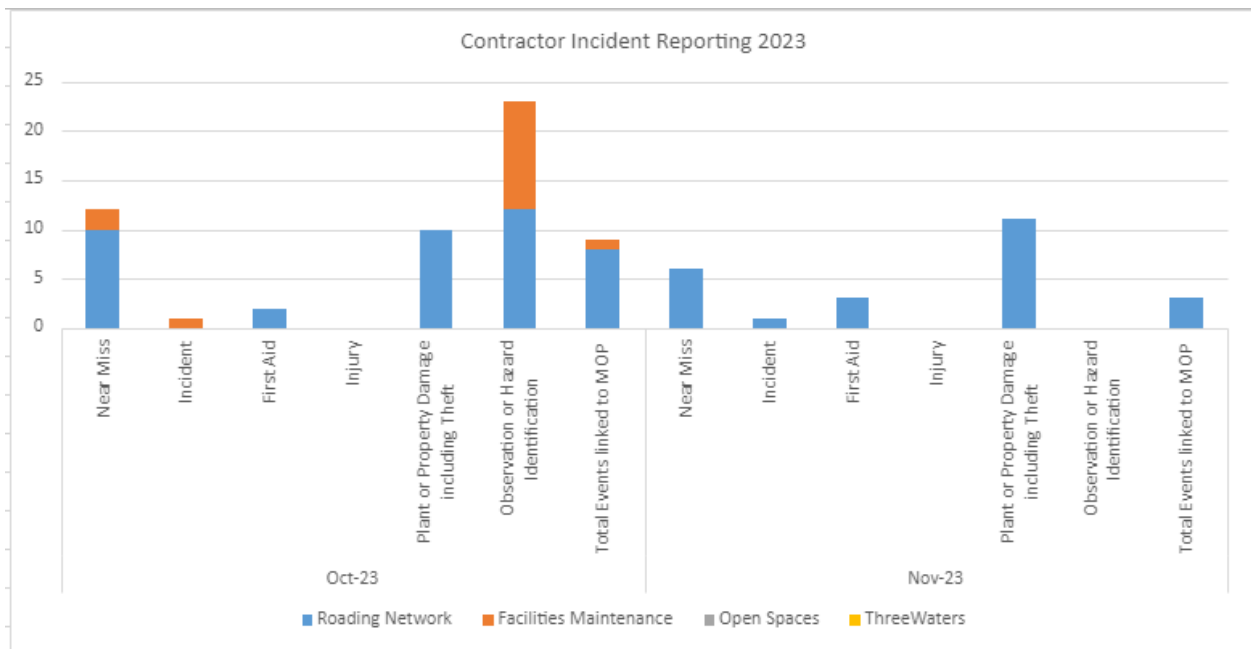

Performance Reporting and Management

Council's Zero Harm performance across several health and safety metrics for November 2023 are shown below. The results for the period July 2022 to June 2023 are included for comparison.

Measures	July 22 to June 23	November 23 (Annualised)	Commentary
Incidents reported in BWare Safety Manager (Lead)	218	91 (218)	
Total Recordable Injuries (TRIs) e.g., Lost Time Injury, Restricted Work Injury or Medical Treatment Injury (Lag)	4	3	

WorkSafe NZ Notifiable Events (<i>Lag</i>)	0	0	
First Aid Injuries (<i>Lag</i>)	18	10 (24)	1 first aid injury (strain to back) reported while poling dog out of ute
Serious Near Miss incidents (<i>Lead</i>)	3	0	
Near Miss incidents (<i>Lead</i>)	77	21 (50)	A slight reduction in near miss reporting has been noticed over the last three months. The Zero Harm team has and will continue to message the importance of reporting.
New Hazards (<i>Lead</i>)	81	47 (112)	We continue to see a positive upward trend with the identification of new hazards. Twelve hazards were reported in November
Zero Harm Engagement Conversations (<i>Lead</i>) KPI is >162 conversations per month or 1944 annually	2066	1031 (2475)	A positive trend in the number of Zero Harm Engagement conversations being undertaken has continued in November

The attached Zero Harm Dashboard (Attachment 1) illustrates safety performance for November 2023.

Critical Safety Risk Management

On Road Driving

A review of the On Road Driving critical risk control plan has commenced with the involvement of staff from across the business, including the Chief Executive.

The first step in the review has been to ensure all current threats (causes) are still relevant and that we have not missed any. To date, four threats have been reviewed and safety critical controls have been identified and agreed by the working group. Further meetings have been scheduled to complete this review.

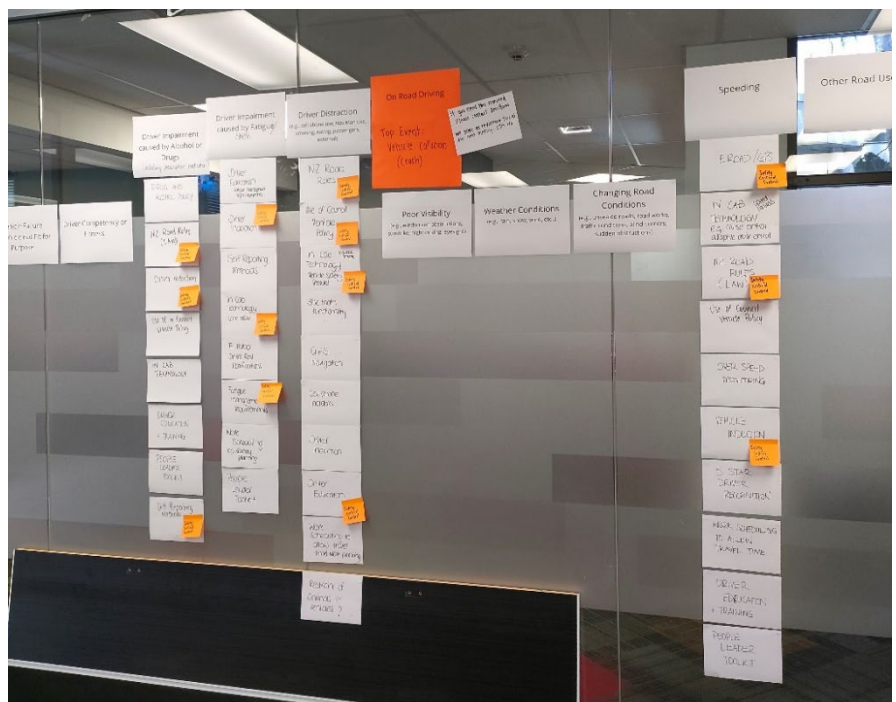

Workplace Violence

The review of the control plan for the critical risk of Workplace Violence continues, and we have now started examining the recovery controls.

The independent review and risk assessment of our library/office site security control measures will be undertaken between the 12th and 14th December, and it is expected that the report and recommendations will be received before we close for Christmas.

Mental Wellbeing at Work

The review of the critical risk control plan for Mental Wellbeing at Work, has continued over the last month. To date we have reviewed 11 of the 22 threat (cause) pathways. Based on feedback from a recent staff survey, we are planning to focus on Mental Wellbeing again during WSHS 2024. The following diagram illustrates the size of the current control plan for managing the risk of work-related mental wellbeing.

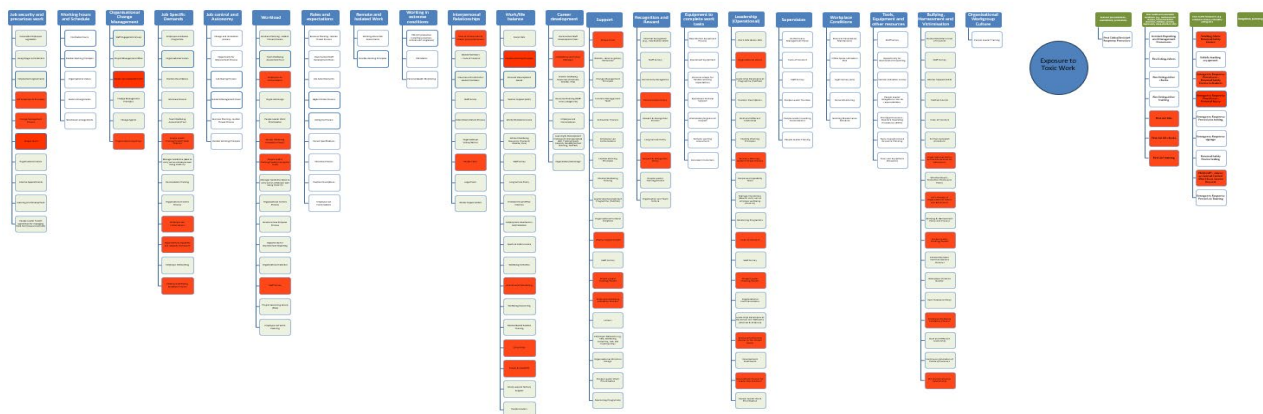

Working on the Road or Roadside

In mid-December 17 staff from the Open Spaces and Monitoring Teams are booked to attend Temporary Traffic Management (TTM) Inspector training. This training has been identified as a key control for managing the risks associated with undertaking activities on the road or roadside. Once this training has been completed, we will then be able to commence the risk control plan gap analysis for each team.

6. Attachments **Ngāa taapirihanga**

Attachment 1 – Zero Harm Performance Dashboard November 2023



Incident Management

Incident Reports by Business Unit (Normalised)

1

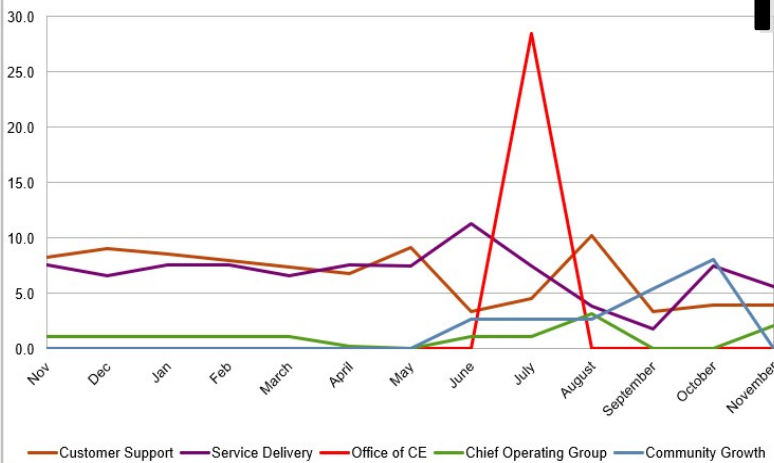

FY 23/24 Total Recordable Injuries (TRI) tracker

2

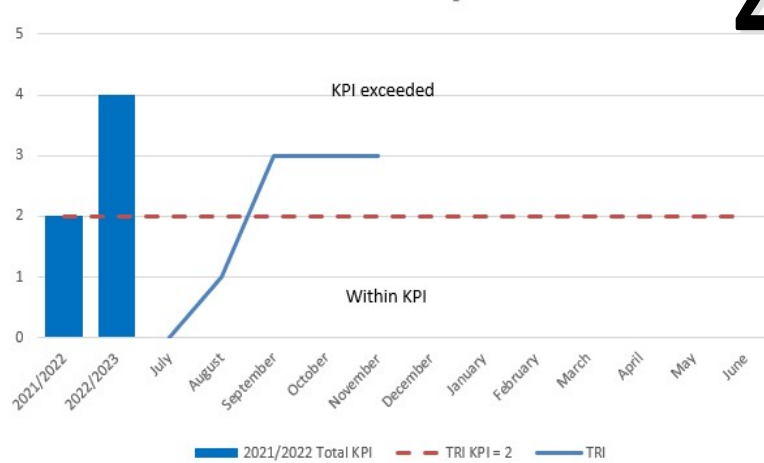

Incidents linked to a Critical Risk

3

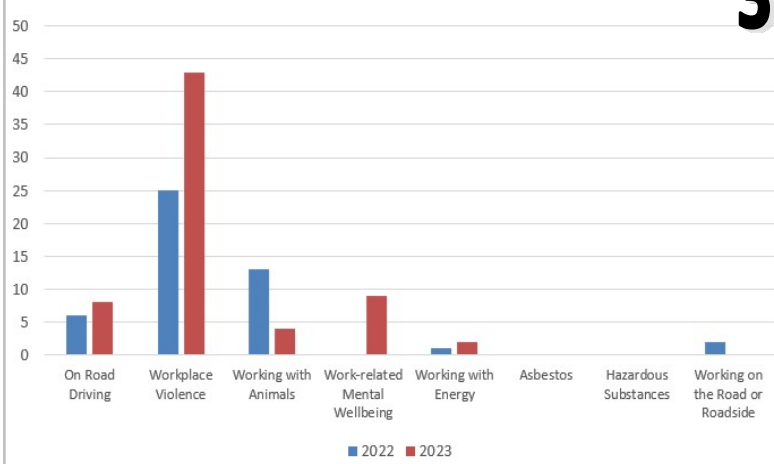

Top Nature of Injury - Year to date

4

- Burn/scald/irritation
- Bruising or crushing
- Laceration/cut/abrasion
- Sprain or strain

Top Mechanisms of harm - Year to date

- Chemicals or other substances
- Fall, trip or slip
- Hitting objects with part of body
- Being hit by moving objects
- Body stressing

Hazard & Risk Management

New Hazards identified within last 6 months by Critical Risk. Inc. noncritical risks occurring >3 times.

5

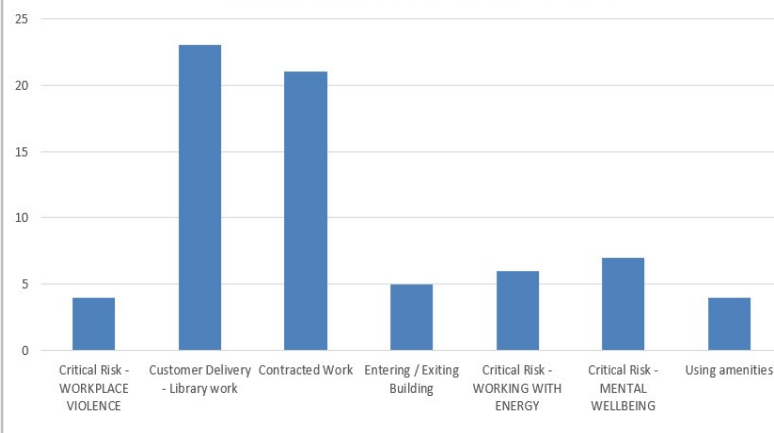

Safety Leadership & Culture

Zero Harm Engagement Conversations

6

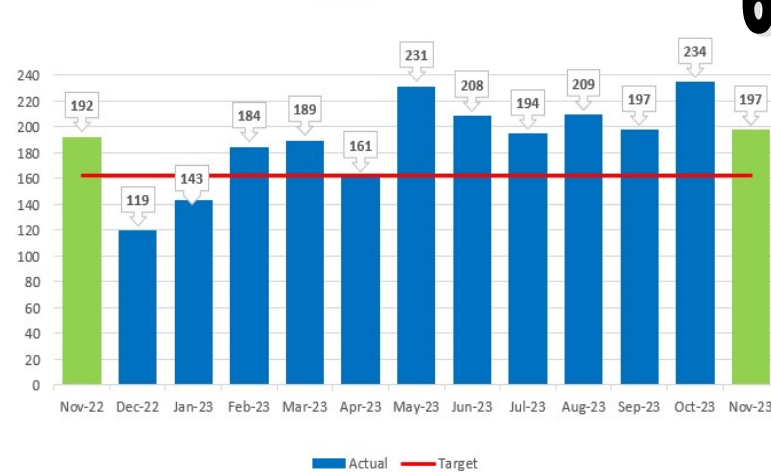

Commentary

Graph 1 shows the volume of incidents (normalized) being reported in Wware Safety Manager by each business unit each month. We have noticed a slight decrease in reporting across some business units and continue to remind our people of importance of reporting all health and safety incidents regardless of their significance.

Graph 2 shows the number of Total Recordable Injuries (TRIs) being recorded against our KPI target. No TRIs were recorded in October and November

Graph 5 shows that most of our new hazards are being identified while undertaking tasks in our Library sites or from contractors completing contracted work or facilities maintenance

To	Waikato District Council
Report Title	Annual Dog Control Report 2022-2023
Date:	5 December 2023
Report Author:	Tracey Oakes, Team Leader Animal Control
Authorised by:	Roger MacCulloch, General Manager Customer Support

1. Purpose of the report

Te Take moo te puurongo

To seek approval from Council to publish the 2022/2023 report on the administration of Council's Dog Control Policy and practices being carried out by the Council, as required by section 10A of the Dog Control Act 1996.

2. Executive summary

Whakaraapopototanga matua

Section 10A of the Dog Control Act 1996 requires each Territorial Authority to report annually on the administration of Council's Dog Control Policy, adopted under section 10 of the Act, and any other dog control practices being carried out by the Council. The Territorial Authority must give public notice and make the report publicly available.

A Dog Control Report is compiled annually by this Council and contains the information required under section 10A along with additional information for the public.

The purpose of this report is to request Council's approval for the 2022/2023 Dog Control Report (as **attached**) so that Council can give public notice and the report can be placed on the Council website for the community, in accordance with our legislative obligations.

3. Staff recommendations

Tuutohu-aa-kaimahi

THAT the Waikato District Council:

- a. **approves the Annual Dog Control Report 2022/2023 (as attached to this report – refer Attachment I) for release to the community via our website.**
-

4. Background

Koorero whaimaarama

Section 10A of the Dog Control Act 1996 states;

10A Territorial authority must report on dog control policy and practices

- (1) *A territorial authority must, in respect of each financial year, report on the administration of—*
 - (a) *its dog control policy adopted under [section 10](#); and*
 - (b) *its dog control practices.*
- (2) *The report must include, in respect of each financial year, information relating to—*
 - (a) *the number of registered dogs in the territorial authority district:*
 - (b) *the number of probationary owners and disqualified owners in the territorial authority district:*
 - (c) *the number of dogs in the territorial authority district classified as dangerous under [section 31](#) and the relevant provision under which the classification is made:*
 - (d) *the number of dogs in the territorial authority district classified as menacing under [section 33A](#) or [section 33C](#) and the relevant provision under which the classification is made:*
 - (e) *the number of infringement notices issued by the territorial authority:*
 - (f) *the number of dog related complaints received by the territorial authority in the previous year and the nature of those complaints:*
 - (g) *the number of prosecutions taken by the territorial authority under this Act.*
- (3) *The territorial authority must—*
 - (a) *give public notice, as defined in [section 5\(1\)](#) of the Local Government Act 2002, of the report; and*
 - (b) *make the report publicly available, as described in [section 5\(3\)](#) of that Act.*

5. Discussion

Matapaki

The Section 10A report is **attached** as Schedule One to this report for the 2022/2023 period. The 2023/2024 year will be reported on in the next financial year.

The key information is summarised below, for comparative purposes *Table 1: Key Data 2021/22 and 2022/23* is included to show any emerging trends.

Table 1: Key Data – 2020/2021 and 2021/2022

Requests for Service	2021/2022	2022/2023
Dog Nuisance	209	242
Stray/Trespass	1,024	1215
Property Visit (owner classifications/unregistered etc)	225	339
Dog Welfare	71	101
Trap Required	18	21
Dog to collect (Surrendered)	84	146
Dog Attack	391	309
Other (includes Livestock Trespassing, Animal Charges for impounded dogs, missing dog reports, assisting police etc)	778	886
Subsidised Dog Desexing Project	56	82
Total number of Requests for Service	2,856	3341

Classifications	2021/2022	2022/2023
Total Number of Probationary Owners	0	0
Total Number of Disqualified Owners	8	1
Total Number of dogs classified as Dangerous	29	23
Dangerous by Owner Conviction Under S31(1)(a)	0	0
Dangerous by Sworn Evidence S31(1)(b)	26	18
Dangerous by Owner Admittance in Writing S31(1)(c)	3	3
Total Number of Dogs Classified as Menacing	170	157
Menacing under S33A(1)(b)(i) by Behaviour	85	83
Menacing under S33A(1)(b)(ii) by Breed Characteristics	4	4
Menacing under S33C(1) by Schedule 4 Breed	81	70

Registration	2021/2022	2022/2023
Total number of known dogs	15,752	16016
Total number of registered dogs	14,351	14089
Percentage of registered dogs	91.11%	87.96%

Infringements Issued	2021/2022	2022/2023
Number of infringements issued	442	215

Prosecutions	2021/2022	2022/2023
Number of prosecutions initiated	2	2
Number of prosecutions completed	2	2

Impounded Dogs	2021/2022	2022/2023
Total number of impounded dogs	682	884
Impounded dogs returned to owner	296	367
Impounded dogs euthanased	167	332
Impounded dogs rehomed	217	181
Held pending prosecution	2	4

In comparing the two years of data, the emerging trends are as follows:

- Overall, all categories of service requests have increased except the Dog Attack category which has decreased.
- This drop in dog attacks is explained by the marked increase the year before. This year's number is in line with previous years.
- The number of impounded dogs has increased this year. Contributing factors are an increased number of dogs surrendered to Council and more dogs collected while wandering at large. The Service Requests in these categories have increased. A common theme in the surrendered dog numbers has been litters of unwanted puppies which could be related to the cost-of-living crisis. This trend has also been noted by other councils around the country.
- There has been an increase in the number of dogs desexed using the PUP project. This was a direct result of extra funds being raised through Dirty Dog profits. We aim to drive this harder in the coming year with another substantial top up to the fund from this year's Dirty Dog event.
- Registration Compliance has seen a drop this year. Reminder notices were not sent out and the Animal Control Team experienced an unsettled period of staffing which has resulted in recruitment. This is still on going with one role to fill in the Ngaaruawaahia team. We have recently created a position that is part time pound keeping and part time compliance. It will be a focus of this role to improve registration compliance.
- The increase in euthanised dogs can be accounted for with the number of puppies that have been impounded this year and have been unwanted. Disease has been an issue when there have been large numbers in the pound despite the best hygiene efforts of the staff. Rescue groups that we have used in the past have been overwhelmed with dogs and have been unable to assist with the moving of dogs. And several dogs failed their temperament test meaning they were unsuitable for rehome.

It is noted that the Act requires council to report on our Dog Control Policy. The Dog Control Bylaw and The Dog Control Policy were adopted in May 2022. It requires review within 5 years of adoption.

6. Next steps

Ahu whakamua

By releasing the report and making it available for public viewing, the activities of Animal Control will be transparent and accessible to our communities.

Public notice will be given to advise of the release of the report and the document will be made available on the Council website once approved for release.

Section 10A of the Dog Control Act 1996 requires that the report is prepared, advertised by public notice and made available to the public.

7. Attachments

Ngaa taapirihanga

Attachment 1 – Section 10A Report for 2022/2023

Attachment 2 – Waikato District Council Dog Control Policy 2022



ANIMAL CONTROL

1 JULY 2022 – 30 JUNE 2023



About this report

Section 10A of the Dog Control Act 1996 requires each local council to report on its dog control policy and practices every financial year. This report is for the Waikato District Council Animal Control team from 1 July 2022 to 30 June 2023.

Dogs in our district

The Waikato district covers more than 400,000 hectares – both rural and urban. In the past 5 years the known numbers of dogs in our district has increased each year. This reflects the continued growth in our communities. There were 16,016 known dogs in the Waikato district, as of 30 June 2023. This is an increase of 264 dogs from the previous year. Approximately 11.7% of the registered dogs in our district are registered on a Farm Owner Policy.



One of our Animal Control Officers at the Pound Pups Pool Party in Tuakau

Our team

As of 30 June 2022, we had 13 staff to deliver animal control services in the district:

- 1 Team Leader
- 1 Senior Animal Control Officer
- 8 Animal Control Officers
- 2 Pound Keepers
- 1 Education and Engagement Officer

The team is supported by administrators in the Community Safety Support team (2 staff members dedicated to the Animal Control team).

During the year there was an assessment on the needs of the Animal Control team. Two additional positions were created and filled before June 2023.



Our policies and rules

The Waikato District Council Animal Control team operates under the following policies and rules:

- Waikato District Council Dog Control Policy 2022
- Waikato District Council Dog Control Bylaw 2022
- Dog Control Act 1996 • Impounding Act 1955.

Note: The Waikato District Council Dog Control Policy and Dog Control Bylaw were renewed in 2022. Public consultation was held over 7 weeks, and we received 666 submissions, with 71 submitters speaking at the hearing. After hearing public feedback, several changes were made to the original proposal. The Council adopted the Bylaw and Policy on 11 April 2022.

The Bylaw and Policy documents can be found here: www.waikatodistrict.govt.nz/services-facilities/animal-control. These will need to be reviewed within the next 5 years.

Our services

Our Animal Control team provide a 24 hour/7-day service. Staff have a work roster to cover after-hour emergencies.

The team takes a 3 E approach: engagement, education and enforcement. This has been our approach for several years and the team has seen a significant improvement in the way our community interacts and engages with the Animal Control team. The team strives to build relationships with people in the community, where appropriate.

We have a great relationship with the Huntly West Hub and Ngaruawahia Community House, where we hand out dog food donations to people in need in the community (thanks Hills Pet Nutrition!) and provide advice on various dog related issues.



Dog registration fees

Waikato District Council has a scaled fee structure for registration. This rewards dog owners who have no history of offences, have continuously registered their dog/s and who meet the property requirements specified within our policies. We also offer a reduced registration fee for dog owners who have registered their dogs before 20 July.

Of the 16,016 known dogs in our district, there are 14,089 registered – a percentage of 87.96%. The Animal Control team engages with dog owners who have not registered their dogs in an appropriate time frame to ensure compliance is achieved. It is a continued focus for the team to increase this overall compliance percentage.

The full fee structure can be found on our website: www.waikatodistrict.govt.nz/your-council/plans-policies-and-bylaws/plans/fees-and-charges

Waikato District Council
June 13 · 🌐

Dog owners - it's time to renew your dog registration. Pay by 20 July to get a \$20 discount per dog. You'll also go in the draw to win a free registration for the year (applies to one dog only).
📧 If you receive your dog registration notice by email, make sure you check your spam folder. Emails were sent out last week.
📧 If you get your notice by post, it should have arrived by the end of the week. If you don't receive it, let us know by emailing dogs@waidc.govt.nz.
To register online: <https://ow.ly/Mr0250LTJq>

What is your dog registration \$ used for?

Percentage	Category
28%	Responding to complaints
25%	Proactive patrols
15%	Education (Includes visits to schools, community groups and library programmes)
10%	Stock safety
8%	Dog pounds
7%	Vehicle costs
6%	Administration
2%	Equipment
1%	Subsidised de-sexing

37 23 comments 14 shares

Impounded dogs

There were 884 dogs impounded this year: 367 of these dogs were returned to their owner, 332 dogs were humanely euthanised. 4 dogs are being held pending prosecution, 177 dogs were rehomed and 4 were waiting for new homes in our adoption programme.

Any dog that is not claimed by the owner (and has not been involved in a serious offence) is temperament tested with people and other dogs and those that pass enter our adoption programme.

We work closely with other rescues and charities to ensure that all the dogs in our adoption programme find the right home for them. We work hard to match the right dogs to the right people. In this year we adopted 154 directly to members of the public and transferred 23 to other agencies for rehoming. As of June 30 2023, we had 4 dogs in our adoption programme still in the pound to be adopted.

This year it was noticeable that other animal charities and rescue groups were overwhelmed with numbers. Often, they asked us for assistance. With the help of our Hill Pet Nutrition sponsorship, we were able help some groups with dog food donations.

Sadly, there has been a significant increase in the number of dogs euthanised this year (an increase of 165 dogs). There has been an increase in dogs surrendered that have not passed the temperament test and in the number of puppies being born in our district. A significant number of dogs that have come into the pound have not been vaccinated for Parvo. Often they have been on the streets before entering the pound, which greatly increases the risk of a parvo outbreak in our pound facilities. This has unfortunately led to several puppies being humanely euthanised by the veterinarian due to the severity of this disease.

Desexing

For every dog registration, \$1 goes towards our desexing programme known as PUP – Prevent Unwanted Puppies. This initiative was approved by Waikato District Council in 2017. Owners who hold a community services card can access discounted desexing for their dog at a rate of \$80.

In the 2022/2023 financial year, 82 dogs were desexed for families that otherwise could not afford it. This has many benefits for our community, including fewer unwanted dogs. Desexed dogs are also less likely to roam. Due to the success of our 2023 Dirty Dog event, we have additional funds we can use over the next 12 months and we hope to desex more than 100 dogs in our community.



Our events

We pride ourselves on holding community events that our residents (and people from other districts) can attend. These are an opportunity for our Animal Control Officers to engage with responsible dog owners and for everyone to have a fun day. Our events are always well attended and receive positive feedback. They are often talked about on social media for several weeks after the event.

Pound Pups Pink Walk

We had a successful pack walk around Lake Kainui, with several dogs turning up in fancy dress. This year we had wings, capes, bandanas and tutus galore!



Unfortunately the Park Pup Date organised for Pookeno was cancelled due to very wet weather. This was not rescheduled due to other commitments.

Pound Pups Pool Parties

We held two Pool Party events in April 2022 – one in Ngaaruawaahia and one in Tuakau. These events are held after our pools have closed to the public.

More than 230 dogs attended these events and \$3697 was raised for charities that had supported us throughout the year by helping us re-home adoption dogs – Auckland Puppy Rescue and 4 Paws Animal Rescue Waikato.

The popularity of this event continues to grow every year. We regularly receive comments from dog owners who are impressed at how well organised the event is, and how much fun it is for the dogs.



“Just want to share my gratitude to Waikato Pound Pups for such an awesome event last weekend. The Pool Party was awesome! And I love that something like this exists, and that lovely caring people are behind it.”
Sharon.



Dirty Dog 2022

The Dirty Dog Event was held in July. This was an extremely successful event, with tickets selling out very quickly. We had two start times to ensure we could offer as many spots as possible.

This event is run in conjunction with the Hamilton City Council Animal Education and Control team. We have participants register from all over the North Island.

After all the bills are paid, the profit is split between Waikato District Council and Hamilton City Council. Both Councils use this for their community desexing funds. This means that we can offer more desexing opportunities for our communities at cheaper rates.

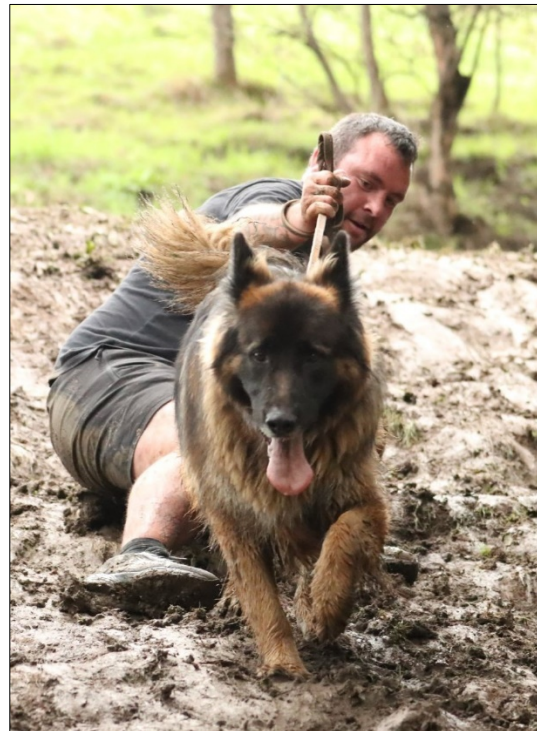



Summary

It has been another challenging year for the Animal Control team. With Covid in the rear-view mirror it is apparent that there has been a considerable dog population explosion in our community and around New Zealand.

The increase in the number of dogs being surrendered and impound numbers are a direct result of this population explosion and the cost-of-living crisis. This has put a strain on resources with the pound facilities often being close to full capacity. Seeing the rescues that we commonly work with struggle with the numbers being surrendered and needing help has been heartbreaking.

Our Prevent Unwanted Puppies (PUP) scheme means we have an opportunity to make a positive impact in our community, and having Hills Pet Nutrition as a sponsor has allowed us to donate food to dog owners, which we are incredibly thankful for.

We continue to prioritise work that may lead to public safety issues and attend jobs such as current stock wandering and dog attacks within one hour. We feel we are adding value to the safety of our community and continue to build positive relationships.

The numbers

REQUESTS FOR SERVICE	
Dog Nuisance	242
Stray/Trespass	1,215
Property Visit (owner classifications/unregistered etc)	339
Dog Welfare	101
Trap Required	21
Dogs to collect (surrendered)	146
Dog Attack	309
Other (includes Animal charges for impounded dogs, missing dog reports etc)	886
Subsidised Dog Desexing Project - PUP	82
TOTAL NUMBER OF COMPLAINTS	3,341

REGISTRATION	
Total number of known dogs	16,016
Total number of registered dogs	14,089
Percentage of registered dogs	87.96

PROSECUTIONS	
Number of prosecutions initiated	2
Number of prosecutions completed	2

IMPOUNDED DOGS	
Total number of impounded dogs	884
Impounded dogs returned to owner	367
Impounded dogs euthanised	332
Impounded dogs rehomed	181
Held pending prosecution	4

CLASSIFICATIONS	
Total Number of Probationary Owners	0
Total Number of Disqualified Owners	1
Total Number of dogs classified as Dangerous	23
Dangerous by Owner Conviction Under S31(1)(a)	0
Dangerous by Sworn Evidence S31(1)(b)	18
Dangerous by Owner Admittance in Writing S31(1)(c)	3
Total Number of Dogs Classified as Menacing	157
Menacing under S33A(1)(b)(i) by Behaviour	83
Menacing under S33A(1)(b)(ii) by Breed Characteristics	4
Menacing under S33C(1) by Schedule 4 Breed	70

INFRINGEMENTS ISSUED		
SECTION	NUMBER	OFFENCE
18	Wilful obstruction of dog control officer or ranger	0
19(2)	Failure or refusal to supply information or wilfully providing false particulars	0
19A(2)	Failure to supply information or wilfully providing false particulars	0
20(5)	Failure to comply with any bylaw authorised by the section	25
23A(2)	Failure to undertake dog owner education programme or dog obedience course (or both)	0
24	Failure to comply with obligations of probationary owner	0
28(5)	Failure to comply with the effects of disqualification	0
32(2)	Failure to comply with the effects of classification of dog as dangerous dog	3
32(4)	Fraudulent sale or transfer of dangerous dog	0
33EC(1)	Failure to comply with effects of classification of dog as menacing dog	6
33F(3)	Failure to advise person of muzzle and leashing requirement	0
36A(6)	Failure to implant microchip transponder in dog	0
41	False statement in relation to dog registration	0
41A	Falsely notifying death of dog	0
42	Failure to register dog	102
46(4)	Fraudulent procurement or attempt to procure replacement dog registration label or disc	0
48(3)	Failure to advise change of ownership	0
49(4)	Failure to advise change of address	0
51(1)	Removal, swapping, or counterfeiting of registration label or disc	0
52A	Failure to keep dog controlled or confined	60

53(1)	Failure to keep dog under control	18
54(2)	Failure to provide proper care and attention, to supply proper and sufficient food, and to provide adequate exercise	1
54A	Failure to carry a leash in public	0
55(7)	Failure to comply with barking dog abatement notice	0
62(4)	Allowing dog known to be dangerous to be at large unmuzzled or unleashed	0
62(5)	Failure to advise of muzzle and leashing requirements	0
72(2)	Releasing dog from custody	0
Total Number of Infringements		215



Dog Control Policy 2022

Policy Owner	Animal Control
Policy Sponsor	General Manager – Customer Support
Approved By:	Policy & Regulatory Committee
Approval Date:	11 April 2022
Resolution Number	WDC2204/13
Effective Date	11 April 2022
Next Review Date:	11 April 2027

Introduction

The Dog Control Act 1996 (Act) requires every territorial authority to adopt a policy on dog control matters and to develop a bylaw to give effect to its policy.

This document contains Waikato District Council's (Council) policy on dogs pursuant to the Act.

This Policy aims to achieve a balance between the recreational needs of dogs and their owners with the need to minimise the potential for any danger, distress or nuisance that may be caused by dogs.

The Waikato District Council Dog Control Bylaw 2022 (Bylaw) gives effect to this Policy, and has been developed to align with this Policy.

Objective(s)

The objectives of this Policy are to:

1. Minimise danger, distress and nuisance caused by dogs in our community
2. Prevent the risk of injury in public places that are frequented by children, whether or not the children are accompanied by adults
3. Enable, to the extent that is practicable, the public (including families) to use streets and public amenities without fear or attack or intimidation by dogs
4. Promote the exercise and recreational needs of dogs and their owners

Definitions

Dangerous dog	means any dog classified as dangerous by Council under Section 31 or Section 33ED of the Act.
Disability assist dog	Has the same meaning as defined in Section 2 of the Act .
Domestic animal	means any animal (including a bird or reptile) kept as a domestic pet; any working dog; any other animal kept by any person for recreational purposes or for the purposes of that person's occupation or employment. Infringement offence has the meaning given to it in Section 65(1) of the Act.
Menacing dog	means any dog classified as menacing under Sections 33A or 33C or 33ED of the Act.
Neutered dog	means a dog that has been spayed or castrated; and does not include a dog that has been vasectomised.
Nuisance	As defined in Section 29 of the Health Act 1956 and includes anything annoying, harmful or offensive to a community or member of it, including noise, smell and threatening behaviour.

Owner	has the meaning as defined under Section 2 of the Act, including every person who owns a dog; or has a dog in his or her possession, or the parent or guardian of a person under the age of 16 years who owns a dog.
Probationary owner	means any owner classified as probationary under Section 21 of the Act.
Protected wildlife	means any animal for the time being absolutely or partially protected under the Wildlife Act 1953 and has the same meaning as defined under Section 2 of the Act.
Public place	Has the same meaning as defined in Section 2 of the Act and includes a place open to or being used by the public. Excludes: <ul style="list-style-type: none"> a) A control dog area or open dog area under Section 26zs of the Conservation Act 1987; and b) A national park constituted under the National Parks Act 1980; and c) Te Urewera, as defined by Section 7 of the Te Urewera Act 2014
Roaming dog	means any dog that is found in any public place or on any land or premises other than that occupied by the owner and is unaccompanied by their owner.
Stock	means any animal that is kept within a fence or enclosure for domestic or farming purposes.
Under control	means keeping a dog under control either by a person by physically limiting its movements, or by using direct commands.
Working dog	Has the meaning as defined in Section 2 of the Act.

Relevant documents and legislation

- [Local Government Act 2002](#)
- [Dog Control Act 1996](#)
- Waikato District Council Dog Control Bylaw 2022
- [Waikato Conservation Management Strategy](#)

Policy review

Council is required to review the Policy if the Dog Control Bylaw 2022 is required to be reviewed.

Application

This Policy affects all dog owners within the Waikato District, people bringing dogs into the district and members of the public.

Policy Statements

The Policy includes:

1. Obligations of Council
2. Responsibilities of Dog Owners
3. Control of Dogs in Public Places
4. Registration of Dogs
5. Managing Troublesome Dogs
6. Micro-chipping of Dogs
7. Education and Caring for Dogs

Section 1: Obligations of Council

Dog owners have a responsibility to provide for their dog's welfare. To support dog owners and the welfare of dogs in the Waikato District, the Council will:

- a) provide dogs and their owners with a reasonable level of access to public places. This will be balanced with the need to protect public safety and to minimise distress and nuisance to the public at large
- b) provide designated exercise areas enabling dog owners to exercise their dogs off lead provided the dogs are kept under control at all times
- c) promote public safety, responsible dog ownership and provisions of the Act and the Council's Dog Control Policy through education programmes for dog owners and the public
- d) encourage the use of approved education and obedience courses for dogs. When dogs have not received proper care and attention the Council will ensure that the appropriate action is taken (i.e. communicate with other agencies such as the SPCA) and may consider enforcement action.

Section 2: Responsibilities of Dog Owners

The responsibilities of dog owners are to:

- a) immediately pick up any dog faeces in a public place. Failing to do so could result in a fine.
- b) ensure their dog does not cause any public nuisance
- c) ensure their dog is registered with the Council, and that the Council is notified of any change of address or ownership of the dog
- d) ensure that the dog is kept under control at all times and confined in such a manner it cannot freely leave its premises
- e) ensure their dog has adequate physical wellbeing through acceptable nutrition, environmental, health and behavioural stimulus, and adequate mental well-being
- f) take all reasonable steps to ensure that the dog does not cause a nuisance to any other person, whether by persistent and loud barking or howling or by any other means
- g) take all reasonable steps to ensure that the dog does not injure, endanger, intimidate, or otherwise cause distress to any person
- h) take all reasonable steps to ensure that the dog does not injure, endanger, or cause distress to any stock, poultry, domestic animal, or protected wildlife
- i) take all reasonable steps to ensure that the dog does not damage or endanger any property belonging to any other person
- j) comply with the Act, and any regulations and bylaws made under the Act.

Section 3: Control of Dogs in Public Places

Unless provided for in the Act or the Bylaw, any dog that enters or remains in a public place must be secured on a lead and kept under continuous control except where otherwise specified in of this Policy.

Under the Act, councils can designate public places where dogs are prohibited or allowed on or off-lead. These areas are enforced using the Bylaw.

3.1 Designated public places

Designated public places are classified as follows:

- a) Prohibited areas– dogs are not allowed in these areas at any time.
- b) Dog exercise areas – dogs can exercise and socialise off-lead.

In all other public places, dogs are required to be on lead. This includes any public area, all roads (including footpaths and road reserves), all boat ramps and slipways.

The schedule of prohibited and dog exercise areas is attached in Schedule One.

3.2 Dogs in outdoor dining establishments

The Council is supportive of food businesses allowing dogs in their outdoor dining areas (except within places specified in Schedule 1) provided the business complies with all regulatory requirements. As with all public places, dogs must be under control at all times. It is up to each individual business to decide if they want to welcome dogs, and if so, to manage any issues that may arise. Disability assist dogs are allowed in all customer areas of all food businesses in accordance with [Section 75\(1\)](#) of the Act.

3.3 Disability and working dogs exemptions

Disability assist dogs and working dogs, if working at the time, are exempt from all public place restrictions specified in this Policy. They do not need to be on-lead in prohibited public places. Disability assist dog exemptions require written authorisation from the appropriate organisation.

3.4 Classification of areas under other legislation

Access for dogs in public places can be controlled by other legislation. Dog owners will need to check to see if the area where they intend to take their dog is controlled. For example, the following areas which are governed by legislation:

- [Conservation Act 1987](#) – “controlled dog areas” and “open dog areas”, through the Department of Conservation
- [National Parks Act 1980](#) – “national park”.

3.5 Exercising dogs at night

If dog owners are exercising dogs at dusk (when visibility is low) or in the evening (particularly in the darker winter months), Council encourages them to use reflective, fluoro or other lighting attached to dog collars or harnesses to help track dogs. It is safer for everyone if people can see their own and other dogs when out and about, particularly on unlit shared pathways. Lighting your dog is a great way to keep track of them at night, especially if they are off lead exercising at dusk or in the early evening. It also allows other public place users to see your dog, preventing any unwelcome surprises or accidents.

Section 4: Registration of Dogs

In accordance with [Section 36](#) of the Act, all dogs in New Zealand must be registered by 30 June each year and must be registered for the first time before they are three months old. Registered dogs should always wear a registration tag. The Council will replace a lost dog registration tag for a small fee.

It is an offence not to register a dog that is over three months of age or to knowingly provide false information on a dog registration application form. A dog not displaying a current registration tag when in a public place may be seized and impounded.

4.1 Dog registration classifications

There are different registration classifications for dogs. Each dog registration classification has different fees.

Those classifications are as follows:

- a) Approved owner
- b) General owner
- c) Selected owner
- d) Farm owner
- e) Dangerous dog
- f) Disability assist dog
- g) Neutered or spayed dog.

A. Approved owner

This is the default owner classification that is applied to all new dog owners who have not previously owned a dog, or current owners who have not been subject to any of the following:

- having a dog impounded
- being the subject of a registered complaint
- having an infringement notice issued against them
- failing to notify Council of changes to ownership details
- repeated non-payment of registration fees; or
- prosecution under the Act.

Any dog owner moving to the district will be given the registration classification of approved owner unless there is evidence of previous history relating to the above criteria in which case the registration classification will be general owner.

Any owner who breaches two or more of the above criteria within a 12-month period will have their approved owner classification cancelled immediately and a general owner classification will apply for a period of two years.

If a dog owner wishes to be recognised as a selected owner or a farm owner, an application to Council is required.

B. General owner

This is the registration classification applied to a dog owner who has been subject to one or more of the following:

- unable to provide evidence of a dog previously registered or has kept unregistered dog under another local authority
- having a dog impounded
- being the subject of a registered complaint
- having an infringement fine issued against them
- failing to notify Council of changes to ownership details
- repeated non-payment of registration fees; or
- Prosecution.

Any owner who has been deemed to have a general owner classification may apply for the reinstatement of approved owner classification but only after two years of clean history.

C. Selected owner

This is the registration classification that applies to a dog owner who complies with the following:

- holds approved owner registration classification and has held that classification for a period of 2 years or more (or the equivalent with another territorial authority)
- complies with the requirements of the approved owner registration classification
- holds a permit where more than two dogs are kept on the premises
- meets the minimum standards for accommodation of dogs (as set out in the Code of Animal Welfare)
- provides a fully fenced dog-proof section or area of the premises, appropriate for the size of the dog/s kept
- any other matter that Council considers relevant in the circumstances.

Any owner who breaches these conditions will have their selected owner classification cancelled and reduced to approved owner classification. Depending on the severity of the breach, an owner

may have their classification reduced to general owner at the discretion of Council's Animal Control Team Leader.

D. Farm owner

This is the registration classification which applies to a rural dog owner who lives on and farms a property of 20 hectares or more, and who:

- currently meets the approved owner classification
- complies with all requirements of the approved owner classification
- meets the minimum standards for accommodation of dogs (as set out in the Code of Animal Welfare)
- ensures that all home killing and the disposal and or treatment of offal and trimmings, including the heads of sheep and goats, are carried out in an approved dog-proof enclosure or killing facility
- does not fed or allow the dog/s access to any raw offal or untreated sheep or goat meat
- will undertake voluntarily treatment for hydatids and sheep measles as part the regular dog worming programme with the local veterinarian.

Any owner who breaches these conditions will have their farm owner classification cancelled and reduced to approved owner classification. Depending on the severity of the breach, an owner may have their classification reduced to general owner at the discretion of Council's Animal Control Team Leader.

E. Dangerous dogs

This is the registration classification applied to dogs which have been classified as dangerous under the Act. In accordance with the Act, a higher registration fee is to be paid by the owners of dogs classified as dangerous.

There is no ability for this classification to be altered, even if the owner of the dog holds any other registration classification.

F. Disability assist dogs

Dogs which are registered as disability assist dogs do not incur a dog registration fee but must still be registered.

Disability Assist Dogs are dogs that are certified as per schedule 5 of the Act.

- Assistance Dogs New Zealand
- Hearing Dogs for Deaf People New Zealand
- K9 Medical Detection New Zealand
- K9 Search Medical Detection
- Mobility Assistance Dogs Trust
- New Zealand Epilepsy Assist Dogs Trust
- Perfect Partners Assistance Dogs Trust
- Royal New Zealand Foundation of the Blind Incorporated

G. Neutered or spayed dogs

The owner of a dog which has been neutered or spayed can apply for a waiver of registration fees for one registration year.

This waiver is subject to the following provisions:

- the waiver has not been applied to the dog previously

- written proof provided from a certified veterinary surgeon confirming the dog has been neutered or spayed
- the dog is not classified as a dangerous dog that has been required to be neutered or spayed under the Act
- the proof and registration form are presented to the Council on or before 31 July of the current year.

4.2 Dog registration fees

Registration fees are set by Council through its Fees and Charges which is set every three years. This document goes through a public consultation process where submissions of the public are invited and heard.

The fees which are agreed upon in the Fees and Charges are notified to all registered dog owners when registration fees are due and are listed on Council's website in the Fees and Charges document.

4.3 Change of dog ownership.

Where the ownership of a dog changes, the registration continues, but both the old owner and the new owner must advise the Council. A new registration tag will be issued to the new owner at no cost.

4.4 Transfer of dog registration between districts

Where a registered dog is moving to a different council district, the registration goes with it. Owners of dogs transferring between areas must advise both councils of the dog's move in writing, and within six weeks of the move. The owner should take the dog registration tag to their new local council office and it will be swapped for a registration tag for the new area, at no charge. No refund of the registration fee is made as a result of the transfer, and the dog is not required to be re-registered in the new area until 1 July.

4.5 Refund of registration fee in the event of the death of a dog

The Council will refund the applicable portion of a dog registration fee in the event of the death of a dog. The refund must be applied for in writing, and must be applied for in the current registration year to receive a refund.

Section 5: Managing Troublesome Dogs

The Act provides tools for Council to manage dangerous or troublesome dog-related situations in order to make our communities safer.

There are offences under the Act which can result in fines. Breaching the Council's Dog Control Bylaw can also result in an instant fine.

However, Council takes the 3E approach of Engagement and Education, then Enforcement. While there are some situations that require enforcement, through the use of fines, classifications or even prosecution, the focus of the Council team is to engage with and educate our community about responsible dog ownership.

5.1 Dog owner status can be reduced due to infringements and offences.

Any dog owner can be reclassified as probationary or disqualified under certain circumstances. A dog may also be classified as dangerous or menacing under certain circumstances.

When a dog owner has committed three or more dog-related infringement offences for separate incidents in a continuous 24-month period or has been convicted of an offence against the Act, the Council must disqualify that owner unless the Council is satisfied that a disqualification is not warranted. In those circumstances, the owner will be classified as a probationary owner.

The classification of a dog owner as probationary or disqualified applies nationwide, not just within the Waikato district.

5.2 Probationary dog owners

If an owner is classified as probationary, they cannot become the owner of any new dogs (but may keep any registered dogs they already have) and must dispose of any unregistered dogs in their possession. Probationary owners may be required to undertake dog owner education or a dog obedience course, or both. Probationary dog owner status generally applies for up to two years but may end sooner.

Sections [21](#) to [24](#) of the Act set out matters relating to dog owners being classified as probationary owners, including the process for objecting to the classification.

5.3 Disqualified dog owners

If a dog owner is disqualified, they cannot be the registered owner of a dog for a specified period and must dispose of every dog that they may own. Disqualified dog owner status can apply for up to five years.

Sections [25](#) to [28](#) of the Act set out matters relating to dog owners being classified as disqualified owners, including the process for objecting to the disqualification and appealing to the District Court.

5.4 Menacing dogs

If a dog constitutes a threat to the safety of people, stock, poultry, domestic animals or protected wildlife because of its behaviour or any characteristics typically associated with the dog's breed or type, the Council can classify it as menacing.

If a dog belongs wholly or predominantly to the breeds of dogs listed in Schedule 4 of the Act, Council must classify the dog as menacing. As at the date of adoption of this Policy, the breeds referred to in the Act are:

- Brazilian Fila
- Dogo Argentino
- Japanese Tosa
- Perro de Presa Canario
- American Pit Bull Terrier type.

Dogs which have been classified as menacing must be muzzled and on a lead in all public places and private ways. Council requires dogs classified as menacing to be de-sexed, according to the Dog Control Bylaw 2022.

The owner of a dog classified as menacing must, as required by the Dog Control Bylaw, produce a veterinary certificate showing the dog has been de-sexed or that it is unfit to be de-sexed. Owners must comply within one month of the classification.

If a dog is required to be de-sexed, the owner may apply to the Council to have the requirement waived on the following grounds:

- there is a veterinary reason for not de-sexing it, or
- there would be a demonstrated potential financial loss to the owner from de-sexing (such as a loss related to breeding or showing the dog).

Sections 33B and 33D of the Act sets out the process for objecting to a dog's classification as a menacing dog (in Sections 33B and 33D).

5.5 Dangerous dogs

If a dog owner has been convicted of an offence under section [57A\(2\)](#) of the Act, or there is sworn evidence that the dog is aggressive and constitutes a threat to the safety of people, stock, poultry, domestic animals or protected wildlife, the Council must classify a dog as dangerous.

Dangerous dogs:

- must be kept within a securely fenced section of the owner's property (and dog-free access to the house must be available at all times)
- must be muzzled and on a lead in all public places and private ways
- must be de-sexed
- incur a registration fee that is 50% higher than a standard dog registration fee
- must not be sold or given away without the written consent of the Council; and
- maintain their status as a dangerous dog no matter where they live in New Zealand.

Sections [31](#) to [33](#) of the Act sets out the effects of a dangerous dog classification and the process for objecting to a dog's classification as a dangerous dog.

5.6 Impounded Dogs

Council impounds a large number of dogs every year. This can be for a variety of reasons, including:

- wandering
- not registered
- attacking animals or people
- surrendered to Council.

Dog owners are not permitted to visit impounded dogs due to health and safety requirements. Impounded dogs are exercised in Council's exercise area. Dog owners are able to register a complaint with Council to appeal dogs being impounded. Pound fees are required to be paid to Council in full before the release of the dog.

Council's Animal Control Team runs a very successful rehoming operation called Waikato Pound Pups.

Except for dogs which are impounded for aggressive behaviour, any dogs that are impounded and not uplifted are extensively temperament tested. All dogs that pass this test are then placed into the rehoming programme. All dogs that are rehomed are desexed, micro-chipped, registered, given a flea and worm treatment, and have received their first vaccination.

Any dogs that do not pass the temperament test are euthanised humanely by a veterinarian.

5.7 The issuing of infringement notices

Council will issue infringement notices or warnings, at a Dog Control Officer's discretion, for infringement offences as set out in [Schedule 1](#) of the Act.

Section 6: Micro-chipping of dogs

6.1 Requirement to have your dog micro-chipped

Except for working dogs, every dog in New Zealand first registered after 1 July 2006 must be implanted with a micro-chip. It is Council policy that any dogs which are impounded by the Council must be micro-chipped before they are released.

A dog must be registered every year, but a dog only needs to be micro-chipped once. A micro-chip is about the size of a grain of rice and is implanted under the skin on a dog's back, by a qualified person such as a veterinarian or Animal Control Officer.

Micro-chipping is a more permanent method of identifying a dog than collars and tags, which can be lost or removed. It enables a dog to be linked to its owner so, if it is stolen or lost, dog and owner can be reunited. It also makes it easier to identify a dog which has been aggressive and classified as dangerous or menacing.

6.2 Requirement to supply micro-chip information

All dog owners are required to supply their dog's micro-chip information to the Council so that it can be recorded in the National Dog Database. This can be done by providing the Council with a certificate from a vet (which includes the micro-chip number), or by taking your dog to the Council's Animal Control Team to have it scanned, to verify that it has a micro-chip.

The National Dog Database is administered by the Department of Internal Affairs and holds details of all microchipped dogs in New Zealand, their owners and any infringements that may have been issued against an owner or person in charge of a dog.

Section 7: Education and caring for dogs

7.1 Dogs in vehicles over the summer months

Council is concerned about the health and welfare of dogs that are left in vehicles during the summer months. The Council takes a strong stance on dogs suffering in hot cars and will act swiftly to release dogs that are clearly in distress. Council's Animal Control Officers may work to release a dog that is in distress and may get assistance of the Police or officers of the SPCA if necessary.

7.2 Dogs at Council events and festivals

Some Council or community events or festivals may not welcome dogs or may require them to be on a lead. This is at the discretion of event organisers and promoters and is not the same as dogs being prohibited or required to be on a lead through the Council's bylaw (unless the event is being held in a place where dogs are prohibited or required to be on a lead). You should always check the requirements of an event before you leave home.

7.3 Education and training

Increased public awareness of safety around dogs, particularly for children, is one of the best ways to reduce dog attacks in the long term. Toddlers and young children should be supervised around dogs at all times. Most dog attacks happen to children in their own home or the home of a relative or friend. The Council offers a free education programme that shows children how to keep themselves safe around dogs. Council also offers a programme where children can read to a dog in the library, while learning about dog safety. Contact the Council for more information or to ask about booking a session.

7.4 Teaching dog safety for workers

Some jobs require people to enter private property, and this can be dangerous if the property has an aggressive dog or a dog defending its territory. For example, common jobs may include couriers, meter readers and census personnel. Council offers an occupational dog safety course that helps employees in these types of roles to recognise and understand threatening dog behaviour to avoid injury or accidents. Contact the Council for more information.

7.5 Learning how to be a good dog owner

Responsible dog ownership and good behaviour from both dog owners and their dogs is another important part of reducing dog attacks, as well as reducing any danger, distress or nuisance that may be caused by dogs. Council is supportive of people undertaking dog training courses of all types. There are many offered by private organisations. As well as behaviour and discipline courses, dog agility courses can be a great way to understand and bond with your dog. Council encourages new dog owners to attend puppy or dog training courses to learn how to train the dog to understand simple commands.

Schedule one: Control of Dogs in public places

Unless provided for in the [Dog Control Act 1996](#) or Waikato District Council Dog Control Bylaw 2022, a dog that enters or remains in a public place must be secured on a leash and kept under continuous control. Public places include:

- Any public area
- All roads (including footpaths and road reserves)
- All boat ramps and slipways.

Exceptions apply where otherwise specified in this Schedule. Maps of these areas are attached to the Dog Control Policy 2022.

Prohibited Areas (District Wide)

No person shall permit any dog to enter or remain in a prohibited area whether it is under control or not, except a working dog while it is working, a dog confined in or on a vehicle, a dog being taken to or from veterinary premises.

Advisory note: exceptions to these restrictions are listed in section 6.5 of the Bylaw.

Locality	Description of area and times	Map #
District wide	<p>Dogs are prohibited from being on:</p> <ul style="list-style-type: none"> • Council playgrounds. This includes fenced or unfenced, surfaced or unsurfaced playgrounds • Sport field playing surfaces • Skateparks <p>Dogs should also be on a lead near playgrounds when they are in use. This is good practice to prevent dogs rushing at children or intimidating them, which could cause an accident.</p> <p>At all times, including public holidays</p>	NA
Huntly	<p>Any street or public place within the central business area of Huntly, including Main Street, Council carpark and rear accesses, at all times including public holidays.</p> <p>At all times, including public holidays.</p>	1
Raglan	<p>Within the Raglan Kopua Camping Grounds, the domain, the playground and picnic area of the foreshore of Oporuru inlet from the footbridge to the boat ramp</p> <p>At all times including public holidays</p>	2
Port Waikato	<p>Within 250 metres north or south of any lifesaving patrolled areas on Port Waikato Beach and Sunset Beach from 10am to 6pm on weekends, public holidays and school holidays from the beginning of Labour Weekend to the end of March the following year.</p>	3
Hakarimata Scenic Reserve	<p>Area from Brownlee Avenue to the dam site on the walkway.</p> <p>At all times, including public holidays.</p>	4
Waireinga Scenic Reserve	<p>Carpark area leading up to Department of Conservation walkway.</p> <p>At all times, including public holidays.</p>	5

Dog Exercise Areas

A dog may be exercised in the areas below free of restraint if kept under continuous control by its owner. Where there is a presence of stock, all dogs must remain leashed.

Advisory note: Council may from time to time by resolution under the Dog Control Bylaw designate additional dog exercise areas.

Locality	Description of area	Map #
Huntly	A fenced area on the shore of Lake Hakanoa situated at the end of Onslow Street in the Huntly Domain	6
	The grassed area along the Waikato River on Riverview Road known as the Riverview Reserve.	7
	Fenced dog park on the corner of Fairfield Avenue and Graham Place	8
Ngaruawahia	Regent Street Reserve. The grassed area from Great South Road to the end of area bordering Turangawaewae Marae.	9
	The fenced area on the corner of Great South Road and Ellery Street situated beside Te Mana O Te Rangi.	10
	Waipa Esplanade Reserve from the Pony Club along the grassed area to the area below Princess Street.	11
Raglan	The fenced area on the corner of Wallis Street and John Street known as Aro Aro Reserve.	12
	Beach area located west of Raglan Holiday Park Papahua.	2
	From the Wainui Reserve carpark at the western end of Te Riria Kereopa Memorial Drive to 300 metres north of the northern walkway at Ngarunui Beach below the Wainui Reserve.	13
	Beach areas from the wharf, the Cliffs, Cox's Bay, Lorenzen Bay, The Doughboys and Moonlight Bay.	14
Te Kauwhata	Fenced areas on the Te Kauwhata Recreation Reserve. Excludes roading areas.	15
Horotiu	Fenced AFFCO Park on Horotiu Road and State Highway 1. Does not include area located by playground	16
	Riverside Reserve on Horotiu Bridge Road.	17
Karioitahi Beach	The beach area known as Karioitahi beach	18
Port Waikato	Sunset beach, beyond 250 metres north or south of any lifesaving patrolled areas. This extends along the shoreline to Maretai Bay, but does not include the reserve area. <i>Advisory note: The area within the lifesaving patrolled areas is prohibited from 10am to 6pm on weekends, public holidays and school holidays from the beginning of Labour Weekend to the end of March from the following year.</i> This is specified in the Prohibited areas schedule.	3
Tuakau	Les Batkin Reserve, in the marked areas specified from Tuakau Bridge to (but excluding) the toilet block and from the	19

	carpark entrance to the northern boundary. <i>Advisory note:</i> The rest of Les Batkin Reserve is on lead, from the carpark entranceway to the northern boundary. Dogs are prohibited in the Les Batkin playground area.	
	Alexandra Redoubt Reserve in the marked areas specified	20
	The grass area at the end of Kowhai Street known as Kowhai Reserve	21
	The marked area in Whangarata Domain.	22
	Centennial Park	23
Pokeno	The fenced area of Pokeno Domain on the southern side of the tennis courts	24
Tamahere	Tamahere Park, located by Tamahere Community Centre and between carpark and road, in marked area	25

To	Waikato District Council
Report title	Schedule of Meetings - 2024
Date:	7 December 2023
Report Author:	Gaylene Kanawa, Democracy Manager
Authorised by:	Gavin Ion, Chief Executive

1. Purpose of the report

Te Take moo te puurongo

The purpose of this report is to seek the Council's approval of a proposed schedule of Council and Committee meetings for 2024.

2. Executive summary

Whakaraapopototanga matua

It is good practice for Council to adopt a schedule of meetings for the following calendar year so that the business of the Council can be conducted in an orderly and transparent manner, and to allow public notification of meetings to be given in compliance with the Local Government Official Information and Meetings Act 1987. Clause 19, Schedule 7 of the Local Government Act 2002 contemplates that a local authority can adopt a schedule of meetings for any future period it considers appropriate.

Once adopted, the schedule of meetings can be amended and notified to elected members. In the event that the Council or a Committee need to meet on an urgent matter outside the proposed cycle, this can be achieved by way of an extraordinary or emergency meeting in accordance with the requirements under the Local Government Act 2002 and Local Government Official Information and Meetings Act 1987.

The proposed schedule is based on the following principles:

- A six-weekly meeting cycle is retained for the Council and three (3) of the four (4) principal committees (Infrastructure, Sustainability & Wellbeing and Performance & Strategy).
 - The Policy & Regulatory Committee Chairperson has agreed to trail a bi-monthly meeting during 2024 as the by-law and policy schedule clearly outlines timelines for the year and will still hold hearings on an "as and when required" basis throughout the year.
-

- The proposed timeline allows for the adoption of the Long-Term Plan and Annual Report without changing any proposed dates for the Performance & Strategy and Risk & Assurance Committees in the 2024 schedule.
- It is noted that hearings from all Committees will be scheduled as and when required to consider by-law review hearings and deliberations, along with any consultative processes for strategies or leases (noting these are under delegation of various Committees).
- The Proposed District Plan Sub-Committee have remained on the current year's schedule of the fourth (4th Thursday of the Month).
- The Waters Governance Board has determined its own meeting dates for 2023 – this has been finalised in some cases and the balance of meetings are currently being worked through with the board members.
- Each Community Board and Community Committee has determined their own meetings schedule for 2024 – separate reports were presented to each Board/Committee for this purpose and their confirmed dates are set out in this schedule.
- The dates for the Co-Governance Joint Committee meetings with Waikato Raupatu River Trust have not yet been finalised with the co-governance group, therefore these will be negotiated and added to the schedule at a later date.
- Workshops will continue to be scheduled to follow on from Council and principal committee meetings. It is further noted that workshops have been scheduled for the Long-Term Plan for Tuesday, 30 and Wednesday, 31 January 2024.

Meeting invitations have been scheduled into Councillors diaries and the Executive Leadership Team diaries as well as independent Chairs on the proviso that these are yet to be confirmed by Council.

Once the schedule is confirmed updates (where required) will be sent to the relevant diaries and the deadlines calendar will be sent to the organisation so they are aware of agenda cut off dates.

3. Staff recommendations Tuutohu-aa-kaimahi

THAT the Waikato District Council:

- adopts the 2024 Meeting Schedule for Council and Committees (refer Attachment 1 to this report).**
- confirms the Governance Structure amendments to reflect the Development Agreements Committee and Policy & Regulatory Committee moving from six-weekly meetings to bi-monthly meetings.**

4. Attachments Ngaa taapirihanga

Attachment A – 2024 Meeting Schedule

January 2024

January 2024							February 2024						
Mo	Tu	We	Th	Fr	Sa	Su	Mo	Tu	We	Th	Fr	Sa	Su
1	2	3	4	5	6	7				1	2	3	4
8	9	10	11	12	13	14	5	6	7	8	9	10	11
15	16	17	18	19	20	21	12	13	14	15	16	17	18
22	23	24	25	26	27	28	19	20	21	22	23	24	25
29	30	31					26	27	28	29			

MONDAY	TUESDAY	WEDNESDAY	THURSDAY	FRIDAY	SATURDAY	SUNDAY
1 Jan 24	2	3	4	5	6	7
<div style="border: 1px solid green; padding: 2px;"> ← From 23-Dec 23 Council offices closed </div>						
<div style="border: 1px solid green; padding: 2px;"> New Year's Day (New Zealand) </div>	<div style="border: 1px solid green; padding: 2px;"> Day after New Year's Day (New Zealand) </div>					
8	9	10	11	12	13	14
15	16	17	18	19	20	21
22	23	24	25	26	27	28
29	30	31	1 Feb	2	3	4
<div style="border: 1px solid green; padding: 2px;"> Auckland Anniversary Day </div>	9:30am Council Workshop : LTP Budgets (Council Chambers) - Democracy	9:30am Council Workshop : LTP Budgets (Council Chambers) - Democracy				

February 2024

February 2024							March 2024						
Mo	Tu	We	Th	Fr	Sa	Su	Mo	Tu	We	Th	Fr	Sa	Su
			1	2	3	4				1	2	3	
5	6	7	8	9	10	11	4	5	6	7	8	9	10
12	13	14	15	16	17	18	11	12	13	14	15	16	17
19	20	21	22	23	24	25	18	19	20	21	22	23	24
26	27	28	29				25	26	27	28	29	30	31

MONDAY	TUESDAY	WEDNESDAY	THURSDAY	FRIDAY	SATURDAY	SUNDAY
29 Jan	30	31	1 Feb	2	3	4
5	6 Waitangi Day (New Zealand)	7	8	9 9:30am Workshop - Future Proof Public Transport Subcommittee (MTG) 11:00am Future Proof Public Transport	10	11
12 9:30am Council Meeting (Council Chambers) - Democracy	13 9:30am Development Agreements Committee (Council Chambers); 6:00pm Tuakau Community Board	14 10:00am Waters Governance Board Meeting (Committee) 1:30pm Raglan Community Board	15	16	17	18
19 9:30am Performance & Strategy Meeting (Council Chambers) - Democracy	20 6:00pm Ngaruawahia Community Board Meeting (Committee Room 1 and 2) - Democracy	21	22 9:30am PDP Subcommittee 4:00pm Placeholder - Proposed February 6:30pm Rural-Port	23	24	25
26 9:30am CEPR Meeting (Boardroom - Te Piringa - West Wing) - 6:00pm Taupiri Community Board	27 9:30am Policy & Regulatory Committee (Council Chambers) - 6:00pm Huntly Community Board	28 9:30am Sustainability & Wellbeing Committee (Council Chambers) - Democracy	29	1 Mar	2	3

March 2024

March 2024							April 2024						
Mo	Tu	We	Th	Fr	Sa	Su	Mo	Tu	We	Th	Fr	Sa	Su
4	5	6	7	8	9	10	1	2	3	4	5	6	7
11	12	13	14	15	16	17	8	9	10	11	12	13	14
18	19	20	21	22	23	24	15	16	17	18	19	20	21
25	26	27	28	29	30	31	22	23	24	25	26	27	28

MONDAY	TUESDAY	WEDNESDAY	THURSDAY	FRIDAY	SATURDAY	SUNDAY	
26 Feb	27	28	29	1 Mar 9:30am Waikato Scheme Subcommittee (Microsoft Teams Meeting; MTG Council Chambers 90+ Grnd Flr)	2	3	
4	5 9:30am Infrastructure Committee Meeting (Council Chambers) - Democracy	6	7 9:30am FPIC Meeting - WRC	8	9	10	
11 9:00am Waikato Mayoral Forum	12	13 9:30am Council : Adoption of LTP Consultation Document (Council Chambers) - Democracy	Gaylene on Leave				17
18	19 10:00am Waters Governance Board Meeting (Committee Room 1 and 2) - Democracy	20	21 9:30am Future Proof Hearings	22 9:30am Future Proof Hearings	23	24	
25 9:30am Council Meeting (Council Chambers) - Democracy 10:00am Waikato Civil Defence Emergency	26 9:30am Risk & Assurance Committee (Committee) 1:30pm Risk & Assurance Committee : Venue/Site 6:00pm Tuakau	27 1:30pm Raglan Community Board Meeting (The Supper Room, Raglan Town Hall, Bow Street,	28 9:30am PDP Subcommittee (Councillors Lounge) - Democracy	29 Good Friday (New Zealand)	30	31	

April 2024

April 2024							May 2024						
Mo	Tu	We	Th	Fr	Sa	Su	Mo	Tu	We	Th	Fr	Sa	Su
1	2	3	4	5	6	7			1	2	3	4	5
8	9	10	11	12	13	14	6	7	8	9	10	11	12
15	16	17	18	19	20	21	13	14	15	16	17	18	19
22	23	24	25	26	27	28	20	21	22	23	24	25	26
29	30						27	28	29	30	31		

MONDAY	TUESDAY	WEDNESDAY	THURSDAY	FRIDAY	SATURDAY	SUNDAY
<p>1 Apr</p> <p>Easter Monday (New Zealand)</p>	<p>2</p> <p>9:30am Performance & Strategy Meeting (Council Chambers) -</p> <p>6:00pm Ngaruawahia Community Board</p>	<p>3</p>	<p>4</p> <p>6:30pm Rural-Port Waikato Community Board Meeting (TBC; (different venue each meeting)) - Democracy</p>	<p>5</p> <p>9:30am Regional Transport Committee (MTG Council Chambers 90+ Grnd Flr) - Councillors Meetings</p>	<p>6</p>	<p>7</p>
<p>8</p> <p>6:00pm Taupiri Community Board Meeting (Memorial Hall, Greenlane Road, Taupiri) - Democracy</p>	<p>9</p> <p>9:30am Development Agreements Committee (Council Chambers);</p> <p>6:00pm Huntly Community Board</p>	<p>10</p> <p>9:30am Sustainability & Wellbeing Committee (Council Chambers) - Democracy</p>	<p>11</p>	<p>12</p>	<p>13</p>	<p>14</p>
<p>15</p>	<p>16</p> <p>9:30am Infrastructure Committee Meeting (Council Chambers) - Democracy</p>	<p>17</p>	<p>18</p>	<p>19</p>	<p>20</p>	<p>21</p>
<p>22</p>	<p>23</p> <p>9:30am Policy & Regulatory Committee (Council Chambers) - Democracy</p>	<p>24</p>	<p>25</p> <p>Anzac Day (New Zealand)</p> <p>9:30am PDP Subcommittee (Councillors Lounge) - Democracy</p>	<p>26</p>	<p>27</p>	<p>28</p>
<p>29</p>	<p>30</p>	<p>1 May</p>	<p>2</p>	<p>3</p>	<p>4</p>	<p>5</p>

May 2024

May 2024							June 2024						
Mo	Tu	We	Th	Fr	Sa	Su	Mo	Tu	We	Th	Fr	Sa	Su
6	7	8	9	10	11	12	3	4	5	6	7	8	9
13	14	15	16	17	18	19	10	11	12	13	14	15	16
20	21	22	23	24	25	26	17	18	19	20	21	22	23
27	28	29	30	31			24	25	26	27	28	29	30

MONDAY	TUESDAY	WEDNESDAY	THURSDAY	FRIDAY	SATURDAY	SUNDAY
29 Apr	30	1 May	2 9:30am Future Proof Deliberations	3 9:30am Future Proof Public Transport Subcommittee (MTG Council Chambers 90+ Grnd Flr) - Councillors	4	5
6 9:30am Council Meeting (Council Chambers) - Democracy 1:00pm LTP Hearings (Council Chambers) -	7 9:30am LTP Hearings (Council Chambers) - 10:00am Waters Governance Board 6:00pm Tuakau	8 9:30am LTP Hearings (Council Chambers) - Democracy 1:30pm Raglan Community Board	9	10	11	12
13 9:30am Performance & Strategy Meeting (Council Chambers) - Democracy	14 6:00pm Ngaruawahia Community Board Meeting (Committee Room 1 and 2) - Democracy	15	16 6:30pm Rural-Port Waikato Community Board Meeting (TBC; (different venue each meeting)) - Democracy	17	18	19
20 9:30am LTP Deliberations (Council Chambers) - Democracy 6:00pm Taupiri Community Board	21 9:30am LTP Deliberations (Council Chambers) - Democracy 6:00pm Huntly Community Board	22 9:30am Sustainability & Wellbeing Committee (Council Chambers) - Democracy	23 9:30am PDP Subcommittee (Councillors Lounge) - Democracy	24	25	26
27	28 9:30am Infrastructure Committee Meeting (Council Chambers) - Democracy	29	30	31	1 Jun	2

June 2024

June 2024							July 2024						
Mo	Tu	We	Th	Fr	Sa	Su	Mo	Tu	We	Th	Fr	Sa	Su
3	4	5	6	7	8	9	1	2	3	4	5	6	7
10	11	12	13	14	15	16	8	9	10	11	12	13	14
17	18	19	20	21	22	23	15	16	17	18	19	20	21
24	25	26	27	28	29	30	22	23	24	25	26	27	28
							29	30	31				

MONDAY	TUESDAY	WEDNESDAY	THURSDAY	FRIDAY	SATURDAY	SUNDAY
27 May	28	29	30	31	1 Jun	2
3 King's Birthday (New Zealand)	4 9:30am Development Agreements Committee (Council Chambers; Committee Room 1 and 2) - Democracy	5	6 9:30am FPIC Meeting - WRC	7 9:30am Regional Transport Committee (MTG Council Chambers 90+ Grnd Flr) - Councillors Meetings	8	9
10	11 9:30am Risk & Assurance Committee (Committee Room 1 and 2) - 1:30pm Risk & Assurance Committee : Venue/Site	12	13	14	15	16
17 9:30am Council Meeting (Council Chambers) - Democracy	18 9:30am Policy & Regulatory Committee (Council Chambers) - 6:00pm Tuakau Community Board	19 10:00am Waters Governance Board Meeting (Committee) 1:30pm Raglan Community Board	20	21 1:00pm HCC/WDC Governance Meeting (Hamilton City Council) - Ashleigh Fairhead	22	23
24 9:30am Performance & Strategy Meeting (Council Chambers) - 10:00am Waikato Civil Defence Emergency	25 9:30am Council : Adoption LTP (Council Chambers) - Democracy 6:00pm Ngaruawahia Community Board	26 2:00pm CEPR Meeting (Boardroom - Te Piringa - West Wing) - Democracy	27 9:30am PDP Subcommittee (Councillors Lounge) - 6:30pm Rural-Port Waikato Community	28 Matariki (New Zealand)	29	30

July 2024

July 2024							August 2024						
Mo	Tu	We	Th	Fr	Sa	Su	Mo	Tu	We	Th	Fr	Sa	Su
1	2	3	4	5	6	7				1	2	3	4
8	9	10	11	12	13	14	5	6	7	8	9	10	11
15	16	17	18	19	20	21	12	13	14	15	16	17	18
22	23	24	25	26	27	28	19	20	21	22	23	24	25
29	30	31					26	27	28	29	30	31	

MONDAY	TUESDAY	WEDNESDAY	THURSDAY	FRIDAY	SATURDAY	SUNDAY
1 Jul 6:00pm Taupiri Community Board Meeting (Memorial Hall, Greenlane Road, Taupiri) - Democracy	2 6:00pm Huntly Community Board (Huntly Library/Waahi Paa) - Democracy	3 9:30am Sustainability & Wellbeing Committee (Council Chambers) - Democracy	4	5	6	7
8	9 9:30am Infrastructure Committee Meeting (Council Chambers) - Democracy	10	11	12	13	14
15	16	17	18	19	20	21
22 9:00am Waikato Mayoral Forum	23	24	25 9:30am PDP Subcommittee (Councillors Lounge) - Democracy	26	27	28
29 9:30am Council Meeting (Council Chambers) - Democracy	30 9:30am Development Agreements Committee 10:00am Waters Governance Board 6:00pm Tuakau	31 1:30pm Raglan Community Board Meeting (The Supper Room, Raglan Town Hall, Bow Street,	1 Aug	2	3	4

August 2024

August 2024							September 2024						
Mo	Tu	We	Th	Fr	Sa	Su	Mo	Tu	We	Th	Fr	Sa	Su
			1	2	3	4							1
5	6	7	8	9	10	11	2	3	4	5	6	7	8
12	13	14	15	16	17	18	9	10	11	12	13	14	15
19	20	21	22	23	24	25	16	17	18	19	20	21	22
26	27	28	29	30	31		23	24	25	26	27	28	29
							30						

MONDAY	TUESDAY	WEDNESDAY	THURSDAY	FRIDAY	SATURDAY	SUNDAY
29 Jul	30	31	1 Aug	2 9:30am Future Proof Public Transport Subcommittee (MTG Council Chambers 90+ Grnd Flr) - Councillors	3	4
5 9:30am Performance & Strategy Meeting (Council Chambers) - Democracy	6 6:00pm Ngaruawahia Community Board Meeting (Committee Room 1 and 2) - Democracy	7	8 6:30pm Rural-Port Waikato Community Board Meeting (TBC; (different venue each meeting)) - Democracy	9	10	11
12 6:00pm Taupiri Community Board Meeting (Memorial Hall, Greenlane Road, Taupiri) - Democracy	13 9:30am Policy & Regulatory Committee (Council Chambers) - 6:00pm Huntly Community Board	14 9:30am Sustainability & Wellbeing Committee (Council Chambers) - Democracy	15	16	17	18
19	20 9:30am Infrastructure Committee Meeting (Council Chambers) - Democracy	21	22 9:30am PDP Subcommittee (Councillors Lounge) - Democracy	23	24	25
26	27	28	29	30	31	1 Sep

September 2024

September 2024							October 2024						
Mo	Tu	We	Th	Fr	Sa	Su	Mo	Tu	We	Th	Fr	Sa	Su
2	3	4	5	6	7	8	7	8	9	10	11	12	13
9	10	11	12	13	14	15	14	15	16	17	18	19	20
16	17	18	19	20	21	22	21	22	23	24	25	26	27
23	24	25	26	27	28	29	28	29	30	31			
30													

MONDAY	TUESDAY	WEDNESDAY	THURSDAY	FRIDAY	SATURDAY	SUNDAY
26 Aug	27	28	29	30	31	1 Sep
2	3	4	5 9:30am FPIC Meeting - WRC	6 9:30am Regional Transport Committee (MTG Council Chambers 90+ Grnd Flr)	7	8
9 9:30am Council Meeting (Council Chambers) - 10:00am Waikato Civil Defence Emergency	10 10:00am Waters Governance Board 6:00pm Tuakau Community Board	11 1:30pm Raglan Community Board Meeting (The Supper Room, Raglan Town)	12	13 1:00pm HCC/WDC Governance Meeting (Committee Room 1 and 2) - Ashleigh	14	15
16 9:30am Performance & Strategy Meeting (Council Chambers) - Democracy	17 9:30am CEPR Meeting (Boardroom - Te Piringa) 6:00pm Ngaruawahia Community Board	18	19 6:30pm Rural-Port Waikato Community Board Meeting (TBC; (different venue each	20	21	22
23 6:00pm Taupiri Community Board Meeting (Memorial Hall, Greenlane Road,	24 6:00pm Huntly Community Board (Huntly Library/Waahi Paa) - Democracy	25 9:30am Sustainability & Wellbeing Committee (Council Chambers) - Democracy	26 9:30am PDP Subcommittee (Councillors Lounge) - Democracy	27	28	29
30	1 Oct	2	3	4	5	6

October 2024

October 2024							November 2024						
Mo	Tu	We	Th	Fr	Sa	Su	Mo	Tu	We	Th	Fr	Sa	Su
	1	2	3	4	5	6					1	2	3
7	8	9	10	11	12	13	4	5	6	7	8	9	10
14	15	16	17	18	19	20	11	12	13	14	15	16	17
21	22	23	24	25	26	27	18	19	20	21	22	23	24
28	29	30	31				25	26	27	28	29	30	

MONDAY	TUESDAY	WEDNESDAY	THURSDAY	FRIDAY	SATURDAY	SUNDAY
30 Sep	1 Oct 9:30am Infrastructure Committee Meeting (Council Chambers) - Democracy	2	3	4 9:30am Waikato Scheme Subcommittee (MTG Council Chambers 90+ Grnd Flr) - Councillors Meetings	5	6
7	8 9:30am Policy & Regulatory Committee (Council Chambers) - Democracy	9	10	11	12	13
14 9:30am Development Agreements Committee (Committee Room 1 and 2) - Democracy	15	16	17 9:30am Risk & Assurance Committee (Committee Room 1 and 2) - 1:30pm Risk & Assurance Committee : Site Visit :	18	19	20
21 9:30am Council Meeting (Council Chambers) - Democracy	22 10:00am Waters Governance Board Meeting (Committee 6:00pm Tuakau Community Board	23 1:30pm Raglan Community Board Meeting (The Supper Room, Raglan Town Hall, Bow Street,	24 9:30am PDP Subcommittee (Councillors Lounge) - Democracy	25	26	27
28 Labour Day (New Zealand)	29 9:30am Performance & Strategy Meeting (Council Chambers) - 6:00pm Ngaruawahia Community Board	30	31 6:30pm Rural-Port Waikato Community Board Meeting (TBC; (different venue each meeting)) - Democracy	1 Nov	2	3

November 2024

November 2024							December 2024						
Mo	Tu	We	Th	Fr	Sa	Su	Mo	Tu	We	Th	Fr	Sa	Su
				1	2	3							1
4	5	6	7	8	9	10	2	3	4	5	6	7	8
11	12	13	14	15	16	17	9	10	11	12	13	14	15
18	19	20	21	22	23	24	16	17	18	19	20	21	22
25	26	27	28	29	30		23	24	25	26	27	28	29
							30	31					

MONDAY	TUESDAY	WEDNESDAY	THURSDAY	FRIDAY	SATURDAY	SUNDAY
28 Oct	29	30	31	1 Nov 9:30am Future Proof Public Transport Subcommittee (MTG Council Chambers 90+ Grnd Flr) - Councillors	2	3
4 6:00pm Taupiri Community Board Meeting (Memorial Hall, Greenlane Road, Taupiri) - Democracy	5 6:00pm Huntly Community Board (Huntly Library/Waahi Paa) - Democracy	6 9:30am Sustainability & Wellbeing Committee (Council Chambers) - Democracy	7	8 1:00pm HCC/WDC Governance Meeting (Hamilton City Council (260 Anglesea Street, Council Building,	9	10
11	12 9:30am Infrastructure Committee Meeting (Council Chambers) - Democracy	13	14	15	16	17
18	19	20	21	22	23	24
25 9:00am Waikato Mayoral Forum	26 10:00am Waters Governance Board Meeting (Committee Room 1 and 2) - Democracy	27	28 9:30am PDP Subcommittee (Councillors Lounge) - Democracy	29	30	1 Dec

December 2024

December 2024							January 2025						
Mo	Tu	We	Th	Fr	Sa	Su	Mo	Tu	We	Th	Fr	Sa	Su
2	3	4	5	6	7	8	6	7	8	9	10	11	12
9	10	11	12	13	14	15	13	14	15	16	17	18	19
16	17	18	19	20	21	22	20	21	22	23	24	25	26
23	24	25	26	27	28	29	27	28	29	30	31		
30	31												

MONDAY	TUESDAY	WEDNESDAY	THURSDAY	FRIDAY	SATURDAY	SUNDAY
25 Nov	26	27	28	29	30	1 Dec
2 9:30am Council Meeting (Council Chambers) - 10:00am Waikato Civil Defence Emergency	3 9:30am Policy & Regulatory Committee 6:00pm Tuakau Community Board	4 1:30pm Raglan Community Board Meeting (The Supper Room, Raglan Town)	5 9:30am FPIC Meeting - WRC	6 9:30am Regional Transport Committee (MTG Council Chambers 90+ Grnd Flr)	7	8
9 9:30am Performance & Strategy Meeting (Council Chambers) - Democracy	10 9:30am Development Agreements Committee 6:00pm Ngaruawahia Community Board	11	12 9:30am Risk & Assurance Committee Meeting 1:30pm Risk & Assurance 6:30pm Rural-Port	13	14	15
16 9:30am Possible Additional Council	17 6:00pm Huntly Community Board (Huntly Library/Waahi Paa) - Democracy	18	19	20	21	22
23	24	25	26	27	28	29
30	31	1 Jan 25	2	3	4	5

To	Waikato District Council
Report title	Delegations to the Chief Executive for the Holiday Period 2023-2024
Date:	7 December 2023
Report Author:	Gaylene Kanawa, Democracy Manager
Authorised by:	Gavin Ion, Chief Executive

1. Purpose of the report

Te Take moo te puurongo

The purpose of the report is to seek the Council’s approval to a temporary, conditional extension of the Chief Executive’s delegations to enable urgent Council decisions to be made during the Christmas/New Year period.

2. Executive summary

Whakaraapopotanga matua

To ensure operations that usually require a decision of Council, or a Committee continue without interruption during the Christmas/New Year Holiday period Council has in the past delegated its responsibilities, duties, and powers to the Chief Executive (except those that cannot be delegated), subject to certain limitations and conditions.

For the purpose of this report, the “Christmas/New Year period” is from Friday, 22 December 2023 until Sunday, 14 January 2024. Any extended delegations would only apply for the restricted time-period noted.

It is Council’s decision whether to approve such a plan or retain the status quo, which would be to implement a meeting of the Emergency Committee as per the Governance Structure. This would require the Emergency Committee to be on “standby” throughout the holiday period should any urgent matters arise.

The Emergency Committee consists of Her Worship the Mayor, the Deputy Mayor, and the Chairpersons of the Infrastructure Committee, Performance & Strategy Committee, and Sustainability & Wellbeing Committee. This Committee would be convened if necessary for any further decisions required from Monday, 16 January 2023 until the next scheduled meeting of Council in mid-February.

3. Staff recommendations Tuutohu-aa-kaimahi

THAT the Waikato District Council:

- a. except as otherwise recorded in this resolution, the Council extends the Chief Executive's current delegations (detailed in the Council's Delegations Register) to include all of Council's responsibilities, duties, and powers currently retained by the Council or delegated to the Council's standing Committees (except the District Licensing Committee), subject to the following conditions:**
 - i. the extended delegations will have effect only for the period from Friday, 22 December 2023 until Sunday, 14 January 2024;**
 - ii. the extended delegations do not include a delegation of any Council responsibilities, duties or powers which are prohibited by law from delegation - including, without limitation, those set out in Clause 32 of Schedule 7 to the Local Government Act;**
 - iii. the Chief Executive may only exercise the extended delegations for those matters that cannot reasonably wait until the next Council or relevant Committee meeting;**
 - iv. where reasonably practicable, the Chief Executive must, before exercising an extended delegation responsibility, duty or power, first consult with:**
 - 1. the Mayor (or the Deputy Mayor if the Mayor is not available); and**
 - 2. the Chairperson (or Deputy Chairperson, if the Chairperson is not available) of the relevant Committee, which would otherwise have the delegated authority to determine the issue for which the Chief Executive is intending to exercise the extended delegations.**
 - v. any decisions made and documents executed in exercising the extended delegations must be reported to the next meeting of Council or relevant Committee;**
 - vi. the extended delegations may be revoked at any time by the Council or the Emergency Committee. In the event there is any inconsistency between this delegation and any other delegations made by the Council, this delegation takes precedence.**
 - b. notes and agrees that, in the event that the Chief Executive is not available, the Chief Operating Officer can exercise any of the extended delegations noted above, subject to the same conditions;**
 - c. temporarily amend the Emergency Committee's Terms of Reference and Delegations to remove the pre-requisite that a Council meeting is precluded due to a lack of quorum before an Emergency Meeting can proceed, provided that:**
 - i. such amended Terms of Reference and Delegations shall apply only for the period from Monday, 15 January 2024 until the next scheduled ordinary meeting of Council in mid-February; and**
-

- ii. all Councillors be invited to any Emergency Committee (via audio visual conference) meeting convened during that period; and
- iii. noting the Emergency Committee would need a quorum of two (2) members in person.

4. Attachments

Ngaa taapirihanga

There are no attachments to this report.

To	Waikato District Council
Report title	Appointment of Council's Representative on the Waikato Scheme Subcommittee
Date:	8 December 2023
Report Author:	Gaylene Kanawa, Democracy Manager
Authorised by:	Gavin Ion, Chief Executive

1. Purpose of the report

Te Take moo te puurongo

To appoint Council's representative on the Waikato Scheme Subcommittee. The Subcommittee will consider and make recommendations to the Integrated Catchment Management Committee, as set out in the attached terms of reference.

2. Executive summary

Whakaraapopototanga matua

The Waikato Regional Council approached Her Worship the Mayor in October 2023 to appoint a representative to the Waikato Scheme Subcommittee.

Cr Patterson is the Chairperson of the Infrastructure Committee and part of that Committee's delegations are:

To support and provide direction regarding Council's involvement in regional alliances, plans, initiatives and forums for regional infrastructure and shared services (for example, Regional Transport Committee).

In line with the Regional Committee appointments for Transport and the delegations of the Infrastructure Committee, Her Worship the Mayor believed it appropriate to recommend the appointment of Cr Patterson to the subcommittee with Cr Whyte as the alternate.

This report formalises that appointment and enables staff to update the Governance Structure.

3. Staff recommendations **Tuutohu-aa-kaimahi**

That the Waikato District Council:

- a. appoints Cr Eugene Patterson (Chairperson, Infrastructure Committee) as Council's representative on the Waikato Regional Scheme Subcommittee.**
- b. appoints Cr David Whyte (Deputy Chairperson, Infrastructure Committee) as Council's alternate representative on the Waikato Regional Scheme Subcommittee if Cr Patterson is unavailable.**

4. Attachments **Ngaa taapirihanga**

Attachment A - Waikato Scheme Subcommittee Terms of Reference.

Waikato Scheme Subcommittee

Terms of Reference / Ngā Tikanga Whakahaere

1. Mana / Status

This is a subcommittee of Integrated Catchment Management Committee and was created by, and at the discretion of Council pursuant to clause 30(1)(a) of Schedule 7 of the Local Government Act 2002. It may be discharged or reconstituted by resolution of Council or Integrated Catchment Management Committee pursuant to clause 30(5)(a) and (b) of Schedule 7 of the Local Government Act 2002.

2. Haupapa / Responsibilities

This Subcommittee is responsible for the provision of local community advice to Integrated Catchment Management Committee in relation to:

- a. Proposed annual flood protection and river management activities undertaken as part of the Lower Waikato Waipā Control Scheme.
- b. Proposed annual land drainage activities undertaken as part of the Waikato Central, Franklin-Waikato and Aka Aka-Otaua land drainage schemes.
- c. Scheme reviews and level of service reviews.
- d. Other matters impacting the operation, maintenance, and renewal of the flood protection and land drainage infrastructure within the above schemes.
- e. Priority areas for Scheme investment.

3. Apatono / Powers

This Subcommittee's powers are limited to the receipt of information and recommendation of local community advice to Integrated Catchment Management Committee on matters directly relevant to its responsibilities set out above.

4. Hererenga Tokoiti / Quorum

Chair or Deputy Chair of the Subcommittee and five other members of the Subcommittee. At least one member present must be an elected member of Waikato Regional Council (refer clause 23(3)(b) Schedule 7 Local Government Act 2002).

5. Potī / Voting

Decisions of the Subcommittee are made by majority vote of members present and voting. In the case of equality of votes, the Chair has a deliberative and casting vote. Refer to clause 24 of Schedule 7 of the Local Government Act and clause 19.3 of *Standing Orders*.

6. Interests, confidentiality, and communication

6.1 Interests

Members must bring to the attention of the Chair any interest that could, or could be perceived to, conflict with their role as a member of the Subcommittee or an item on an agenda. All relevant interests must be disclosed and kept up to date on a register of interests. Management of conflicts may include the member removing themselves from discussion and voting on the relevant item.

6.2 Confidentiality

Members will, from time to time, be privy to confidential information. Any confidential information must not be disclosed until released by Council. The spokesperson for the Subcommittee is the Chair. Except as otherwise allowed or required by law, the meetings are open to the public.

6.3 Communication

The line of communication between Council staff and the Subcommittee members is through the constituent councillor. Issues or actions arising from Subcommittee meetings are responded to by the Chair of Integrated Catchment Management Committee. All formal communication and information updates to members are circulated electronically.

7. Mematanga / Membership

7.1 Pouhere Tangata / Members

- a. The Chair of Integrated Catchment Committee
- b. The Deputy Chair of the Integrated Catchment Committee
- c. One appointed Waikato Regional Council constituent Councillor for either the Ngā Hau e Wha or Waikato Constituent area.
- d. Ten targeted ratepayers as follows:
 - i. Five targeted ratepayers from the Lower Waikato Waipā Control Scheme.
 - ii. Two targeted ratepayers from the Aka Aka-Otaua land drainage area.
 - iii. Three targeted ratepayers from the land drainage subdivisions within the Franklin-Waikato and Waikato-Central land drainage areas.
- e. Six members, one from each of the following entities from each entity's nominations:
 - i. Department of Conservation (nominees must be staff)
 - ii. Mercury (nominees must be staff)
 - iii. Two nominations from Waikato-Tainui (nominees must be trustees or staff)
 - iv. Waikato District Council (nominees must be elected members or staff)
 - v. Hamilton City Council (nominees must be elected members or staff)

Members are appointed by Integrated Catchment Management Committee (refer clause 31 of Schedule 7 of the Local Government Act 2002). No payment is made by Waikato Regional Council for membership on the Subcommittee for time or expenses. Membership on this Subcommittee does not replace Council's obligations to engage directly with Mana Whenua on the matters considered by the Subcommittee.

7.2 Targeted ratepayers

Targeted ratepayer members are appointed by Integrated Catchment Management Committee from expressions of interest advertised to the relevant community by the most effective means considering cost and likely size of audience. Candidates must meet the following criteria:

- a. Be ratepayers receiving a direct benefit from the relevant scheme.
- b. Be willing to accept membership as a volunteer without compensation for either time or expenses.
- c. Be able and willing to receive and deal with Subcommittee documents electronically.
- d. Have interests that will enhance contributions as a member of the Subcommittee.

7.3 Nohoanga kōrua ko Kaitiriwā / Chair and Deputy Chair

The Chair of the Subcommittee is a Waikato Regional councillor appointed by Integrated Catchment Management Committee. A second Waikato Regional councillor is appointed by the Integrated Catchment Management Committee as the Deputy Chair. Both appointments are in accordance with the process set out in clause 25 of Schedule 7 of the Local Government Act 2002.

7.4 Kairiwhi / Alternates

Alternates to any of the members are encouraged and appointed by Integrated Catchment Management Committee from nominations or candidate ratepayers, as relevant.

8. Ngā hui I te tau / Frequency of meetings

Minimum of two meetings per calendar year or as determined by the Integrated Catchment Management Committee, as well as site visits as agreed by the subcommittee. All meetings must be opened and closed with karakia.

To	Waikato District Council
Report title	Exclusion of the Public
Date:	13 November 2023
Report Author:	Gaylene Kanawa, Democracy Manager
Authorised by:	Gavin Ion, Chief Executive

1. **Staff recommendations** **Tuutohu-aa-kaimahi**

a. **THAT the public be excluded from the following parts of the proceedings of this meeting:**
 The general subject of each matter to be considered while the public is excluded, the reason for passing this resolution in relation to each matter, and the specific grounds under section 48(1) of the Local Government Official Information and Meetings Act 1987 for the passing of this resolution are as follows:

General subject of each matter to be considered	Reason for passing this resolution in relation to each matter	Ground(s) under section 48(1) for the passing of this resolution
Item PEX 2 – Minutes for confirmation	Good reason to withhold exists under Section 6 or Section 7 Local Government Official Information and Meetings Act 1987	Section 48(1)(a)
Item PEX 3.1 – Waters Governance Board Recommendations – 28 November 2023		
Item PEX 3.2 – Infrastructure Committee Recommendations – 13 December 2023		
Item PEX 4.1 – Proposed District Plan Appeal – General Rural Zone		
Item PEX 4.2 – Update on Variation 3		

This resolution is made in reliance on section 48(1)(a) of the Local Government Official Information and Meetings Act 1987 and the particular interest or interests protected by Section 6 or Section 7 of that Act which would be prejudiced by the holding of the whole or relevant part of the proceedings of the meeting in public, as follows:

Item No.	Section	Interest
Item PEX 2 – Minutes for confirmation		Refer previous minutes for reasons for exclusion.
Item PEX 3.1 – Waters Governance Board Recommendations – 28 November 2023		Refer to Waters Governance Board agenda for reasons for exclusion.
Item PEX 3.2 – Infrastructure Committee Recommendations – 13 December 2023		Refer to Infrastructure Committee agenda for reasons for exclusion.
Item PEX 4.1 – Proposed District Plan Appeal – General Rural Zone	7(2)(g)	To maintain legal professional privilege
Item PEX 4.2 – Update on Variation 3	7(2)(g)	To maintain legal professional privilege

2. Attachments Ngaa taapirihanga

There are no attachments for this report.